

Sandec: Department of  
Sanitation, Water and Solid  
Waste for Development

# Gravity-driven Membrane Filtration

A User Guide





## Impressum

<b>Published by:</b>	Eawag – Swiss Federal Institute of Aquatic Science and Technology Department of Sanitation, Water and Solid Waste for Development (Sandec) Überlandstrasse 133, 8600 Dübendorf, Switzerland Phone +41 58 765 52 86
<b>Cover picture:</b>	Lukas Bouman
<b>Photos &amp; Figures:</b>	Eawag and OST (unless stated otherwise)
<b>Layout:</b>	Lukas Bouman
<b>Language Editing:</b>	Paul Donahue
<b>Authors:</b>	Lukas Bouman, Regula Meierhofer, Dr. Maryna Peter, Dr. Céline Jaquin, Kennedy Wanyama, Henry Ouma, Prof. Dr. Michael Burkhardt, Rias Stalder, Christof Biba
<b>Corresponding authors:</b>	<a href="mailto:lukas.bouman@eawag.ch">lukas.bouman@eawag.ch</a> ; <a href="mailto:regula.meierhofer@eawag.ch">regula.meierhofer@eawag.ch</a>
<b>Published:</b>	2022
<b>Free Access:</b>	<a href="http://www.sandec.ch/gdm-manual">www.sandec.ch/gdm-manual</a>
<b>ISBN:</b>	978-3-906484-79-2
<b>Quote as:</b>	Bouman L., Meierhofer R., Peter M., Jaquin C., Wanyama K., Ouma H., Burkhardt M., Stalder R., Biba . (2022). "Gravity-driven Membrane Filtration - A User Guide." Eawag: Swiss Federal Institute of Aquatic Science and Technology, Dübendorf, Switzerland



The content of this document is licensed under a Creative Commons Attribution 4.0 International license



# Gravity-driven Membrane Filtration

A User Guide

Written and published with financial support from the Swiss Agency for Development and Cooperation (SDC)



Schweizerische Eidgenossenschaft  
Confédération suisse  
Confederazione Svizzera  
Confederaziun svizra

**Swiss Agency for Development  
and Cooperation SDC**



# Table of contents

<b>Glossary</b>	<b>VIII</b>
<b>About this user guide</b>	<b>X</b>
<b>Part I: The GDM technology</b>	<b>1</b>
1 The technology explained	2
2 Components of a GDM system	4
<b>Part II: Horizontal GDM example</b>	<b>10</b>
1 Source: Lake water	12
2 Intake: Site specific	12
3 Abstraction: Solar pump	14
4 Treatment: GDM filtration	16
5 Distribution and transport: Water kiosk and jerrycans	24
6 Lessons learnt from practice	25
<b>Part III: Vertical GDM example</b>	<b>27</b>
1 Source: Groundwater	29
2 Intake: Infiltration well	29
3 Abstraction: Electric pump	29
4 Treatment: GDM filtration	30
5 Distribution and transport: Water taps and jerrycans	30
6 Other GDM applications	31
<b>Part IV: User safety</b>	<b>32</b>
1 Recontamination	34
2 Chlorination	34
3 Safe storage	38
<b>Part V: Sustainable Management</b>	<b>40</b>
1 Water quality monitoring	42
2 Business model	47
3 Management models	51
4 Enabling environment	54
<b>References</b>	<b>55</b>
<b>Appendix</b>	<b>59</b>
A Trouble shooting for GDM kiosks in Eastern Uganda	59
B Manuals for operators of GDM kiosks in Eastern Uganda	63
C T-chlorinator: Building instructions and user manual	70
D AkvoTur: Building instructions and user manual	73
E Taking a water sample	75

# Glossary

<b>Backflushing</b>	Maintenance procedure usually applied in membrane filtration, where the water flows backwards through the membranes and cleans them. Backflushing is not required in the presented systems using flat sheet ultrafiltration membranes.
<b>Biofilm</b>	A collective of microorganisms that grow on a surface and are encompassed within the self-produced extracellular matrix material. They are important in gravity-driven membrane filtration as they grow on the ultrafiltration membranes and prevent them from clogging. They also grow in jerrycans where they can cause recontamination.
<b>Bulkhead connector</b>	Plumbing part used to connect a tank with a pipeline
<b>Check valve</b>	Plumbing part that allows water only to flow in one direction in a pipeline
<b>Colony forming unit, CFU</b>	A unit used in water quality analysis to estimate the number of viable bacteria cells in a sample. Colony forming units can be detected by the human eye after an incubation period.
<b>Compact dry plates, CDP</b>	Pre-fabricated, dry agar plate used for microbiological water quality analysis. The main advantages of compact dry plates are that they are user-friendly and have long shelf-life.
<b>E. coli</b>	Escherichia coli bacteria. Widely used indicator bacteria of faecal contamination. They are present in very high numbers in human and animal faeces and are rarely found in the absence of faecal pollution.
<b>Eawag</b>	Swiss Federal Institute of Aquatic Science and Technology
<b>Flushing outlet, Flushing valve</b>	Outlet at the bottom of the membrane tank that allows draining the membrane tank. This is a necessary maintenance procedure of a GDM system.
<b>Flux stabilization</b>	Long-term stabilization of the water flux through membranes. This means, that membranes don't clog in the long-term. Flux stabilization in a GDM system is enabled by the porous biofilm that grows on the membranes.
<b>Flux, LMH</b>	A unit to measure the productivity of membranes. LMH (L/m <sup>2</sup> /h) stands for the litres of water (L) that can be filtered by a square metre (M) of membrane area in one hour (H).
<b>Free residual chlorine FRC</b>	Amount of chlorine available for disinfection in water. It does not include combined chlorine that is bound in nitrogen compounds and less effective for disinfection.
<b>Gravity-driven membrane filtration, GDM</b>	Water treatment technology to treat turbid water using ultrafiltration membranes and the force of gravity. Only minor operation and maintenance works are required.
<b>Infiltration trench</b>	Pit in the ground filled with coarse material that allows excess or overflow water to drain and therewith prevents flooding
<b>Intake</b>	Location, where the raw water is withdrawn from the source in a gravity-driven membrane filtration system.



<b>Log reduction value, LRV</b>	A unit to measure the bacterial removal efficiency of a treatment process. It is determined by taking the logarithm of the ratio of contamination (e.g. colony forming units of E. coli) before and after the treatment.
<b>Membrane filtration</b>	Method to separate particles from a solution. This guide describes how ultrafiltration membranes can be used to produce potable water. Membrane filtration also refers to a water quality analysis method in which pathogens in the water samples are retained by a membrane filter and cultivated on an agar plate.
<b>Membrane integrity test</b>	Procedure to assess the effectiveness of a membrane to remove bacteria
<b>Operation and maintenance, O&amp;M</b>	Procedures and activities that are required to keep a system functioning in the long term. The burden and costs of operation and maintenance are particularly important for sustainability considerations.
<b>OST</b>	Eastern Switzerland University of Applied Sciences
<b>Polyethersulfone, PES</b>	Polyethersulfone is a membrane material (see Part I, section 2.4.3)
<b>Pore size</b>	The size of the “holes” in a membrane. Ultrafiltration membranes have a nominal pore size in the range of 1 - 100 nanometres (100 nanometres = 0.1 micrometres)
<b>Recontamination</b>	Previously contamination-free water is polluted again due to contact with contaminated materials. Contamination may originate from biofilms in the storage container and sediments or can enter from outside via openings (dust, animals, contaminated hands or cups, etc.). Unhygienic environments are prone for recontamination.
<b>Re-growth</b>	Pathogens in water that has not completely been disinfected, encounter optimal growth conditions (nutrients and optimal growth conditions). This enables them to multiply.
<b>Roughing filter</b>	A filtration method used to separate suspended solids from water. They are made of rather coarse filter material.
<b>Safe storage container</b>	Container to store drinking water at the household level that reduces the risk of recontamination with special features.
<b>Strainer</b>	A metal mesh installed at the suction point where the raw water is sucked by the pump. It retains larger particles and sediments and protects the pump.
<b>Total coliforms</b>	Bacterial indicator that is abundantly present in natural waters and used in water quality analysis. However they are of no sanitary health significance.
<b>Ultrafiltration membranes, UF</b>	Ultrafiltration membranes are used to filter contaminated water and make it potable in the gravity-driven membrane filtration technology. They are able to remove turbidity, bacteria, viruses and protozoa, but not salinity nor dissolved chemical contamination.
<b>WASH</b>	(Drinking) Water, Sanitation and Hygiene
<b>WHO</b>	World Health Organization

# About this user guide

Interventions to improve water quality are an important strategy to reduce the burden of disease in low-income areas. This guide describes gravity-driven membrane (GDM) filtration, a technology to provide safe and affordable drinking water in rural areas. It is based on the experience of different people and projects, and on insights gained during more than 10 years of technology evaluation in the laboratory and in the field in Kenya, Bolivia, South Africa, Liberia and Uganda. GDM was originally developed at Eawag (Peter-Varbanets et al., 2010) and since then has been evaluated and implemented by multiple organisations and research teams (Pronk et al., 2019, Jain, 2019). The authors would like to acknowledge everyone who helped to develop this guide. Particular thanks go to the partner organisations that supported the implementation of the GDM technology. In Uganda these were Water School Uganda, Africa Water Solutions and Get Water Uganda and in Liberia the Bowier Trust Foundation Switzerland Team. They were involved in the planning, construction, operation and maintenance of the GDM kiosks and in the dissemination of the GDM technology. Without the dedication and commitment of these partner organisations the GDM technology would never be at its current stage. Our thanks also go to the local communities, who participated in the planning and development process, spent time in many meetings, contributed with materials, land and labour and took ownership of the kiosks.

## Target audience & purpose

The target audience of this guide are implementers of projects to improve drinking water quality: Technicians and decision-makers of civil society organisations and governmental institutions as well as lecturers of institutions of higher education. Some technical background is needed to follow the guide. After reading the guide, the reader should be able to:

1. Judge, whether GDM is a suitable technology for his or her project
2. Understand, how the GDM technology works
3. Know, how a GDM water treatment system can be constructed and installed
4. Understand the requirements for operation and maintenance of a GDM treatment system
5. Understand, which elements contribute to a sustainable long-term operation of the technology

## GDM described in 150 words

GDM stands for gravity-driven membrane filtration. It is a technology that can treat microbiologically polluted, turbid raw water in one step. The heart of the treatment system contains of ultrafiltration modules with a nominal pore size ("holes") of 20-40nm. In conventional ultrafiltration, the operation & maintenance (O&M) is complex. The membranes need to be operated with high pressure, backwashed several times a day and cleaned with chemicals. In contrast, the GDM approach is using low pressure and needs minimal O&M because the biological activity in the biofilm on the membranes prevents clogging (see Figure 1), leads to flux stabilisation and therewith suppresses the need for backwashing and chemical cleaning. Depending on the design, a pump might only be needed to convey the water to the treatment site. The membranes retain particles, bacteria, protozoa, as well as a fraction of the dissolved organic carbon and viruses. Compared to conventional ultrafiltration, where mechanical and chemical cleaning is implemented to keep fluxes around 60 L/m<sup>2</sup>/h, the water production per membrane area is lower for GDM set-ups (4 - 20 L/m<sup>2</sup>/h).

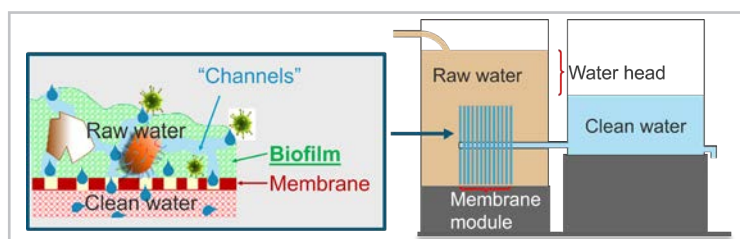

Figure 1: Schematic overview of GDM treatment

## Navigating through this guide

The guide is structured into five parts:

### Part I: The GDM technology

This part explains the GDM technology in detail and gives an overview of the different components of a GDM water treatment system.



### Part II: Horizontal GDM example

This part focuses on the horizontal GDM system configuration. A case study from Uganda is presented to illustrate the different components from water source to water distribution. Furthermore, the installation as well as operation & maintenance procedures are described.

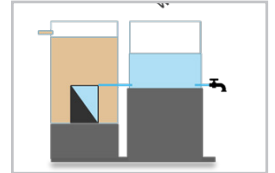

### Part III: Vertical GDM example

This part focuses on the vertical GDM system configuration. A case study from Liberia is presented to illustrate the different components from water source to water distribution.

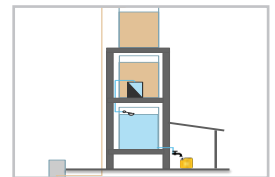

### Part IV: Recontamination and user safety

Research showed that water, which is collected at the water point, might not be safe until a user consumes it. Part IV of this guide explains the importance of this topic.



### Part V: Management

Besides technology, many other aspects need to be taken into consideration. This part highlights the importance of having a reliable water quality monitoring, a robust business model and a reliable management system to organise the operation of a GDM system and a framework to support project implementation.



Throughout the guide, the following boxes are used:

Highlights issues of high importance



Highlights useful references



Alternatives to suggested solutions in presented examples



To complement this guide, a video series was produced. The first part of the series gives a concise overview of the key topics of this guide. The second part of the series illustrates the maintenance procedures of a GDM system and the installation of the membrane modules.

Scan the QR code to watch our video series "How to run a GDM water filtration system" or go to <https://www.youtube.com/playlist?list=PLASQULqsVHg7y-Weeqqvy4eKDJUB49NI5R>



# Part I: The GDM technology



# 1 The technology explained

The GDM technology uses ultrafiltration (UF) membrane modules to treat water. The driving force for filtration of this low-pressure approach is gravity in the form of a water head of 0.3 - 1 m (ca. 30 - 100mbar) above the membrane, as opposed to pumps in high-pressure applications (1 - 3 bar).

The pore size of 20 - 40 nanometres ( $=0.00002 - 0.00004$  millimetres) retains suspended solids (silt, clay, algae, etc.,  $>1000$  nanometres), protozoa ( $>1000$  nanometres), bacteria (approximately 200 - 2000 nanometres) and most viruses ( $\sim 20 - 500$  nanometres). After a few days of operation, a cake-layer consisting of a biofilm develops on the surface of the membrane (see Figure 2), given that no mechanical and chemical maintenances are implemented.

Biological activity in the biofilm, causes the formation of cavities and keeps the biofilm porous, which leads to the long-term stabilisation of the flux through the membranes (see Figure 3).

The membranes, therefore, do not clog and can be operated during an extended period without need for regular back-flushing and cleaning. Flushing the membrane tank once per month and a check-up once per year are the regular maintenance tasks recommended. The flushing procedure

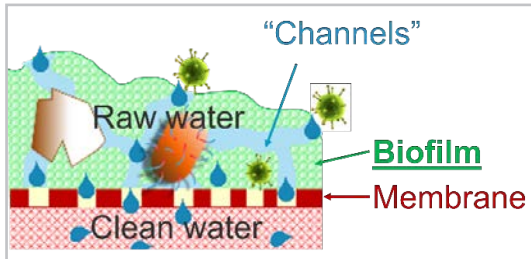

Figure 2: Sketch of a biofilm

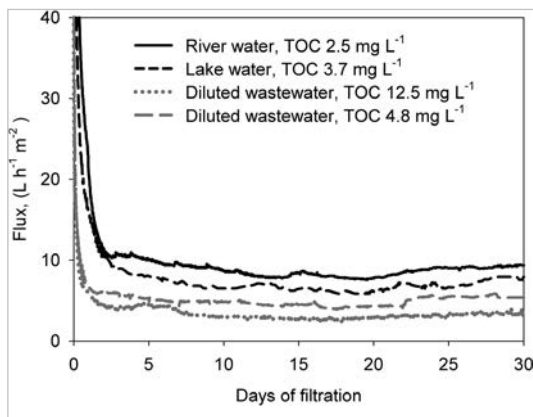

Figure 3: Flux stabilization after a few days for different water types (Peter-Varbanets et al., 2010)

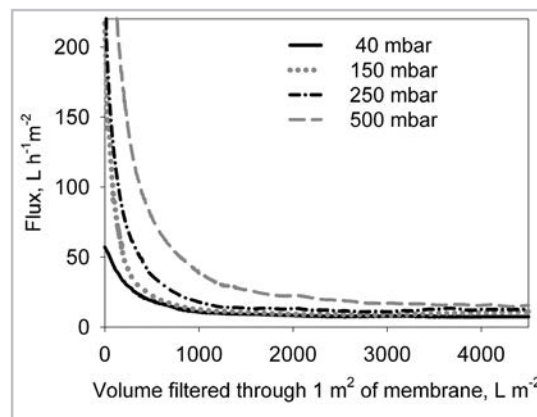

Figure 4: Flux stabilization at different transmembrane pressures (Peter-Varbanets et al., 2010)

removes all the sediments and suspended particles that have been retained by the membranes and removes parts of the biofilm. During the yearly check-up, the connections are controlled to avoid leakages.

In conventional UF treatment plants that apply water pressures of more than 0.5bar, the set-up incorporates an intense O&M schedule (backwashing and chemical cleaning) to maintain a high flux through the system. The GDM technology minimises O&M requirements and drastically reduces the complexity of O&M and the set-up. In comparison to conventional UF treatment plants lower fluxes are accepted. Fluxes of 4 - 20L/m<sup>2</sup>/h have been observed in the field for the GDM set-up, about 10 - 100 times less than in conventional set-ups.

Various parameters influence the biofilm properties and the flux values through the membranes.

- Feed water containing higher amounts of organic matter forms biofilms with higher resistance. Higher resistance is equal to lower flux through the membranes. Therefore, river water leads to a lower flux than rain water. For example, the accumulation of algae-derived products results in low oxygen contents and low biological activity in the biofilm, which reduces the flux (Lee et al., 2019). Higher concentrations of dissolved oxygen result in higher biological activity and higher flux (Pronk et al., 2019).
- Relaxation periods or intermittent operation increases the flux (40 - 60 % increase with 1-8h relaxation, (Oka et al., 2017). Peter-Varbanets et al. (2012) as well as Tang et al. (2016) confirm this finding.

- Temperatures in the range of 20 - 45 °C support the growth of mesophilic bacteria that form the biofilm on the membranes. Akhondi et al. (2015) observed an increase of flux of 20 % when raising the temperature from 25 to 29 °C.

Interestingly, a long term study over 1 year demonstrated that changing the water head did not result in a significant change of stable flux (Peter-Varbanets et al., 2010). This study found that in the range of 40-500 mbar (= 0.4 - 5 m water head), the flux did not depend on the transmembrane pressure (see Figure 4). Also, Tang et al. (2016) report only a minor increase in flux from 6.6 L/m<sup>2</sup>/h at 65 mbar compared to 8.6 L/m<sup>2</sup>/h at 200 mbar (= 0.65 m).

GDM is especially suitable to treat microbiologically polluted, highly turbid surface waters, like water from rivers, lakes or ponds, if the membrane surface is adapted to compensate for the low fluxes. It is also suitable to treat less turbid water like ground water, rainwater or spring water. The GDM technology does not remove dissolved chemicals or geogenic contaminants (e.g. arsenic or fluoride). Therefore, it is not suitable to treat water sources affected by mining wastewater, industrial wastewater or pollutants from agriculture, such as pesticides.

Table 1: Key figures of the GDM technology

Treatment technology	Ultrafiltration membrane (nominal pore size 20 - 40 nm)
Driving force	Gravity
Transmembrane pressure	Min 30 - 100 mbar (0.30 - 1 m water)
Treatment capacity	4-20 L/m <sup>2</sup> /h, (depending on raw water quality, time of last flushing of the membrane tank, temperature, etc.) = 300 - 900 L/h with field tested modules of 75 - 80 m <sup>2</sup>
Costs of membrane module	~ 50-200 \$ per 1 m <sup>2</sup> membrane area
Lifespan	~ 10 years (estimation by membrane producers, may be longer as membranes are less strained in GDM set-ups compared to conventional set-ups)
O&M recommendations	<ul style="list-style-type: none"> <li>• Flush membrane tank (Once per month)</li> <li>• Disinfect clean water tank (Once every 2 months)</li> <li>• Check connections and state of module (Once per year)</li> </ul>

Advantages and disadvantages of the GDM technology in rural drinking water supply systems in the developing context:

**Advantages:**

- GDM treats highly turbid water without the need for pre-treatment
- Simple design and installation
- No electricity is required for the treatment process
- No regular backwashing or chemical cleaning of the membranes is required
- Only very limited operation & maintenance work is required

**Limitations:**

- GDM does not filter dissolved chemical contaminants of natural (geogenic contamination) nor anthropogenic origin (agriculture, industry or mining) and does not remove salts
- The membrane modules need to be imported and cannot be produced locally so far
- A GDM system needs trained operators to carry out maintenance works
- The initial investment costs are substantial

Scan the QR code to watch the video "Introducing the GDM technology" of our series or go to <https://youtu.be/SuUOehE1fzg>



## 2 Components of a GDM system

In this section an overview is provided of all the components of a GDM system to provide safe water from the source to the point of collection. The components are chosen in analogy to the functional groups of the Compendium of Water Supply Technologies in Emergencies (Coerver et al., 2021). The compendium gives a complete overview of the water supply technologies from the source to the point of consumption and is an excellent reference book. Part II and Part III of this guide provide an applied and more detailed discussion for a horizontal and a vertical GDM system.

### 2.1 Source

GDM can treat a wide variety of different raw waters: from little contaminated sources, such as rainwater, spring water or groundwater, to highly turbid surface waters (rivers, lakes, ponds or dams). The UF membranes remove particles with a size larger than 20 - 40nm from the water such as turbidity and microbiological contamination. Contamination with a smaller particle size, such as dissolved ions or molecules, are not removed. Therefore, GDM does not remove geogenic contamination (Fluor or Arsenic), chemical contamination (pesticides, industrial chemicals, cyanobacterial toxins) or salinity from the water. If no additional, specific treatment is foreseen to remove geogenic or chemical contamination, the source water for GDM treatment must not contain these kinds of contamination. Source water with high salinity concentrations, such as brackish water or seawater, is also not suitable for GDM treatment. To treat geogenic, chemical or salt contamination, other technologies need to be considered, such as reverse osmosis or activated carbon. Potentially cheaper water treatment options exist to purify less turbid waters (like rainwater, spring water and groundwater). Therefore, the GDM technology is particularly suitable for the treatment of microbiological contamination in turbid water, as treatment efficiency of most other water treatment technologies is challenged in turbid water.

### 2.2 Intake

An intake adapted to the raw water source is installed to withdraw the water. For rain-water, a roof water collection or a rainwater catchment is constructed. Protected spring intakes are built for spring water, and protected boreholes, dug wells and subsurface storage dams collect groundwater. Intakes need to be constructed to collect water from surface water, such as rivers and lakes.

The design of an intake for surface water is chosen on the basis of the quality of the raw water, the properties of the ground, the shore and other local circumstances. Debris and larger particles are screened by a strainer at the suction point. However, too many particles will clog the strainer. Additionally, most pumps have difficulties in dealing with sediments and sand in water that runs through the pump. Therefore, the water that is sucked should not contain sand or sediments. If particles are present they can be removed by sedimentation or pre-filtration.

The simplest intake design withdraws water directly from an open water source: The pipe with the strainer attached sucks water directly from the water body. In some cases, the pipe may be attached to a float (could be a jerrycan). If the raw water is too turbid, direct abstraction from the water source is not recommended and a pre-filtration of the raw water is required. Pre-filtration can be achieved by installing an infiltration well, such as a dug well, on the shore of the water body. Through an infiltration well, water is pre-filtered through the ground. A precondition for the proper functioning of an infiltration well is the presence of porous soil such as for example sand. If the properties of the ground do not allow for an infiltration well, it is recommend to install an infiltration well with a pre-filter. In this case, the original ground between the water body and the well is excavated and replaced by sand or gravel that has a higher permeability.



A useful overview of different intake constructions for lakes, ponds and rivers is provided by (Skinner and Shaw, 1999) and (Wegelin, 1992).

Table 2: Comparison of intake structures for lake water

Direct strainer intake	
<ul style="list-style-type: none"> <li>+ Easy to install</li> <li>+ Cost-effective</li> <li>+ Sedimentation prior to abstraction in the water body</li> </ul>	<ul style="list-style-type: none"> <li>- Not robust: Pipe to the suction point is exposed to turbulence of the lake (waves), floating vegetation or damage by human or animal activities</li> <li>- Intensive operation and maintenance: The strainer needs to be cleaned often to avoid clogging</li> <li>- Floating vegetation may clog the strainer</li> </ul>
Infiltration well	
<ul style="list-style-type: none"> <li>+ Soil provides a natural pre-filter. Removes particles and thereby protects the pump</li> <li>+ Sedimentation of particles in the well</li> <li>+ Well protected suction point, no interference with activities in the lake</li> <li>+ Robust and long-lasting</li> <li>+ Low O&amp;M requirements</li> </ul>	<ul style="list-style-type: none"> <li>- Only possible in sandy, permeable ground</li> <li>- Higher investment costs than direct intake</li> </ul>
Unprotected intake followed by roughing filtration	
<ul style="list-style-type: none"> <li>+ Can be constructed independent of the ground conditions</li> <li>+ Well protected suction point, no interference with activities in the lake</li> <li>+ Removal of particles protects the pump</li> <li>+ Sedimentation of particles in the well</li> <li>+ Robust and long-lasting</li> <li>+ Low operation &amp; maintenance</li> </ul>	<ul style="list-style-type: none"> <li>- Higher investment costs than infiltration well</li> <li>- Complex to construct</li> <li>- Replacement of filter material necessary after some years</li> </ul>

### 2.3 Abstraction

Different forms of energy sources can be used to abstract the water from the source and transport it to the treatment facility. The type of water source, the water quantity required, the elevation and distance between the source and the treatment site determine the choice of energy source for water transport. If the source water is higher than the treatment site (spring, upland river or rainwater), gravity can be used to transport the water. If the source water is lower than the treatment site (groundwater or surface water), a pump is needed. To power a pump, diesel, electricity from the grid or renewable energy (wind, solar) can be used. Diesel should be avoided as an energy source, as the operation costs are high, the supply need to be guaranteed and it is not environmentally friendly. If no reliable electric grid is accessible, it is recommended to use renewable energy sources. They offer complete decentralized and autonomous operation, but specific technical skills for installation and maintenance are required.

Solar powered pumps have become especially popular recently and many different models are available. Solar panels convert sunlight into direct current (DC) that drives specially designed solar

The choice of pump type and model is very complex and it is recommended to refer to experienced pump suppliers and mechanics who know the local conditions and can provide a reliable after sale service.



Practical Action Publishing has published an extensive and comprehensive guide on solar pumping for water supplies for humanitarian and development context (Kiprono and Llarío, 2020). It includes a theoretical background about solar energy production, possible configurations and components, design considerations and further information on solar energy.





pumps. Another option is to convert DC into alternating current (AC) and to use a conventional electric pump that runs on AC. Some energy (ca. 25 %) is lost during conversion. Pump suppliers (e.g. Grundfos or Lorentz) have online design software that suggest specific pump models based on input specifications.

Pumps can be classified into three types according to their application: submersible, surface and floating water pumps. A submersible pump usually draws water from deep wells, a surface pump draws water from shallow wells, springs, ponds, rivers or tanks, and a floating water pump draws water from reservoirs with adjusting height ability (Chandel et al., 2015). The performance of a solar water pumping system depends on the solar radiation available at the location, total dynamic head (sum of head from suction point until discharge and friction losses) and the flow rate to achieve required daily capacity. Solar arrays should be sized around two times the estimated power that will be required. The maximum hours of run-time on solar will be nine to ten hours, and typically is lower (six to eight hours per day). To extend the operation of a solar pump and store surplus solar energy, batteries can be used.

Some solar panels and pump components are fragile if exposed to the environment and yet, valuable and desired. These characteristics make the components prone to theft and/or failure. If the water source is distant from the treatment site, the situation is even more delicate. It is, therefore, recommended to discuss these issues with the local experts and to take measures to prevent vandalism and theft.

Table 3: Comparison of pump types

Submersible versus surface pump
In groundwater wells, usually submersible pumps are used. They do not need priming and usually have a higher head. Surface pumps are, however, easily accessible and can be easily installed. Both pump types have difficulties to cope with large amounts of sediments in the raw water. Pumps need to be protected from theft and vandalism.
Solar pump versus electric pump with converter
Solar pumps (DC) are more efficient than electric (AC) pumps with a converter: around 25 % of the electricity is lost when converting DC to AC power. However, electric pumps might be more commonly in use and servicing by local mechanics and spare parts might be more easily available.

## 2.4 Treatment

After abstraction, the water is delivered to the treatment site. The main treatment step in a GDM water treatment system is filtration by an UF membrane. The theoretical background of GDM is described in Part II. As in all water supply systems, the water may be recontaminated during distribution and transport (see Part IV). Therefore, a chlorination step at the treatment site or an additional treatment at the household level in addition to the GDM filtration is recommended.

### 2.4.1 Flat sheet membranes

In flat sheet membranes, several membranes are fitted in parallel into a frame and housed in a cassette (see Figure 5). Several cassettes form one module. During filtration, the water passes

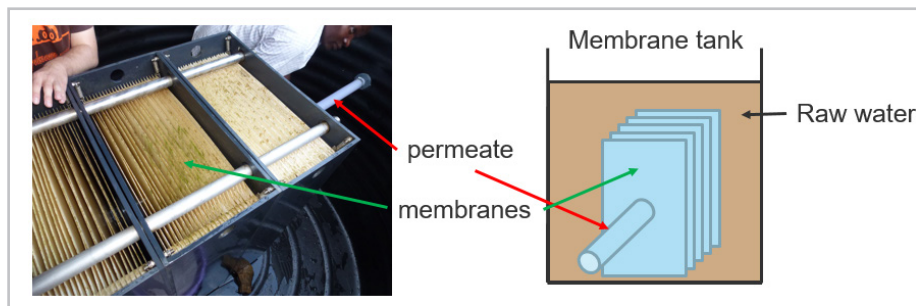

Figure 5: Picture and schema of flat sheet membrane module

from both sides through the membrane. The filtered water (permeate) is collected in a pipe that runs through all membrane sheets and connects the filter module to the water tank containing the disinfected drinking water.

### 2.4.2 Hollow fibre modules

Hollow fibre modules contain membrane tubes (spaghetti-like), as shown in Figure 6. The water flows either outside-in (raw water is outside, permeate inside) or inside-out (raw water inside, permeate outside).

Of all the available UF module geometries, hollow fibre systems offer the highest membrane surface areas per volume (packing density). Since hollow fibre modules are more densely packed, they have less space between the membranes and require regular backwashing as opposed to the flat sheet membrane modules. If the raw water source has a low turbidity, such as rain water, hollow fibre membranes could be taken into consideration (Jain, 2019). Hollow fibre modules are generally available at a lower price compared to flat sheet modules.

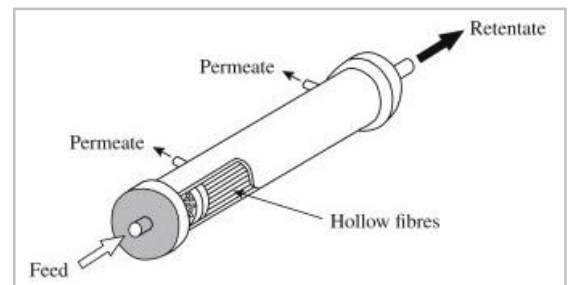

Figure 6: Hollow fibre membrane module (adapted from Doran, 2013)

Table 4: Comparison of different membrane types

Flat sheet versus hollow fibre
Flat sheet: Less clogging, less maintenance (less backwashing and cleaning) than hollow fibre
Hollow fibres: Higher membrane surface areas per volume (packing density), generally lower price than flat sheet

### 2.4.3 Materials used for membranes

Various materials can be used to produce membranes for drinking water treatment. Most widely used are polymeric materials, such as Polyvinylidene fluoride (PVDF) and Polyethersulfone (PES) membranes. Whereas PVDF is resistant to drying, it has to be activated prior to use by soaking the membrane in methanol and then a buffer solution. In the field, activating the membrane might be challenging. PES membranes have a higher permeability, a more uniform pore size distribution and a higher thermal stability than PVDF membranes (Fan et al., 2016). In addition, they do not have to be activated. Also, the drying resistance for PES membranes is improving. Factory new PES membranes are soaked in glycerine to keep them moist during transport and before use. The glycerine should be flushed out entirely from the membranes before operation, as it could provide nutrients for the regrowth of bacteria (see Part II, section 4.2).

Table 5: Comparison of different membrane materials

PES versus PVDF
PES: Higher permeability, more uniform pore size distribution, higher thermal stability than PVDF.
PVDF: Traditionally more resistant to drying than PES.
Both material types need treatment prior to commissioning

#### 2.4.4 Configuration of Ultrafiltration

The GDM technology uses ultrafiltration (UF) membrane modules and the force of gravity to purify contaminated water. The transmembrane pressure is created by the gravity pressure of the water that is to be filtered through the membrane. Water is forced to permeate through the membrane into a lower reservoir. In community-scale treatment systems, two main configurations are possible: the horizontal and the vertical configurations.

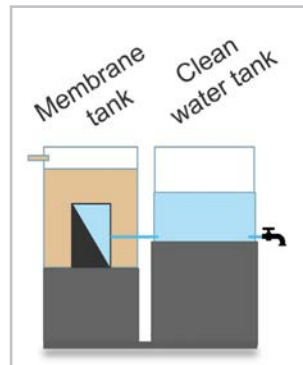

Figure 7: Horizontal configuration

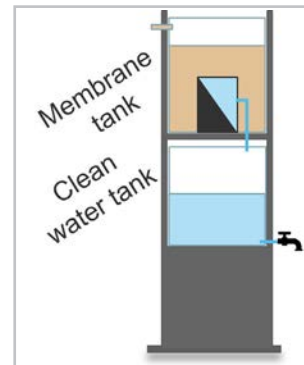

Figure 8: Vertical configuration

In the **horizontal** configuration, at least two tanks are connected horizontally in series: a membrane tank, that contains raw water and the membrane modules, and a clean water tank, which stores the treated water (Figure 7). The resistance of the membrane is overcome by a lower water level in the clean water storage tank. The water flows from the membrane tank through the membranes into the clean water tank as long as the level in the membrane tank is higher. Once the two tanks reach the same level filtration will stop. Intermittent water inflow is not a problem; however it has to be guaranteed that the membranes are always submerged in water!

In the **vertical** configuration, the tanks are arranged vertically in series (see Figure 8). Also, the vertical set-up consists of at least two tanks: the membrane tank and the clean water storage tank. The outlet of the membrane tank is installed above the membrane module to make sure that the membrane module is always submerged in water. Like this, intermittent flow is not a problem. Water permeates until it reaches the level of the outlet in the membrane tank. If the clean water tank is full, a ball valve at the inlet of the clean water storage tank stops permeation and avoids overflow of the clean water tank.

Table 6: Comparison of different ultrafiltration configurations

##### Horizontal versus vertical configuration

Horizontal: Better accessible for O&M, fundamentals are easier to construct as they are lower than in the vertical configuration

Vertical: Less space required than in the horizontal configuration

## 2.5 Distribution and transport

Different water distribution systems exist. A very simple method is water transport in jerrycans by individual customers. Each customer collects water at the treatment site. Although the installation cost of manual transport is very low, it causes a high labour burden to the water buyer. Additionally, water is prone to recontamination, especially if the water is collected in contaminated containers. If there is the demand and ability to pay, water vendors can provide transport services and deliver the water to the household, using bicycles, carts, tuk-tuks or even water trucks. To improve users' access to water, piped distribution networks with public stand pipes or household connections can be built. It needs to be considered that in piped networks water consumption usually increases and they are expensive to build and maintain. Furthermore, intermittent operation can also cause recontamination in piped systems.

Table 7: Comparison of distribution methods

<b>Consumers manually transport water in jerrycans</b>	
<ul style="list-style-type: none"> <li>+ Easy quality control at central treatment facility</li> <li>+ Low cost</li> <li>+ Purchase of small quantities is possible</li> <li>+ Jerrycans are low cost and robust</li> <li>+ Jerrycans are everywhere available</li> </ul>	<ul style="list-style-type: none"> <li>- Risk of poor management (highly dependent on operator)</li> <li>- Risk of recontamination after kiosk</li> <li>- Time needed to collect water</li> <li>- Burden to carry the water</li> </ul>
<b>Water vendors</b>	
<ul style="list-style-type: none"> <li>+ Time savings for water buyers</li> <li>+ Reduced effort</li> <li>+ Business opportunity</li> </ul>	<ul style="list-style-type: none"> <li>- No quality control/guarantees</li> <li>- Higher cost for households (willingness to pay for the service might be low)</li> </ul>
<b>Piped network</b>	
<ul style="list-style-type: none"> <li>+ Convenient for users</li> <li>+ Lower risk of recontamination than if stored in jerrycans</li> <li>+ Usually better hygiene practices at the household level as a result of easier access to water</li> </ul>	<ul style="list-style-type: none"> <li>- High installation costs</li> <li>- High O&amp;M costs</li> <li>- Recontamination risks if operation is intermittent</li> <li>- Demand for water increases</li> </ul>

## Part II: Horizontal GDM example



This case study presents examples of the horizontal configuration of the GDM technology at community scale in five rural locations in Busia and Namayingo districts in Eastern Uganda (see Figure 9). The key figures of the system are presented in Table 8. Water kiosks were installed to treat water from Lake Victoria for five primary schools and the community living in the surrounding areas. The area is characterised by saline groundwater, a high level of self-subsistence farming, inhabitants with very limited economic resources and very limited infrastructure.

Table 8: Key figures of the horizontal GDM example in Uganda

Membrane surface	80m <sup>2</sup>
Tank volumes	Membrane tank: 10 m <sup>3</sup> , Clean water tank: 6 m <sup>3</sup>
Max. Daily water production	6 - 8 m <sup>3</sup>
Nr of households supplied	~ 70
Average water demand	2 – 3 m <sup>3</sup> /day
O&M requirements	
Solar pump input	144-360 Watts, 16-40 Volts

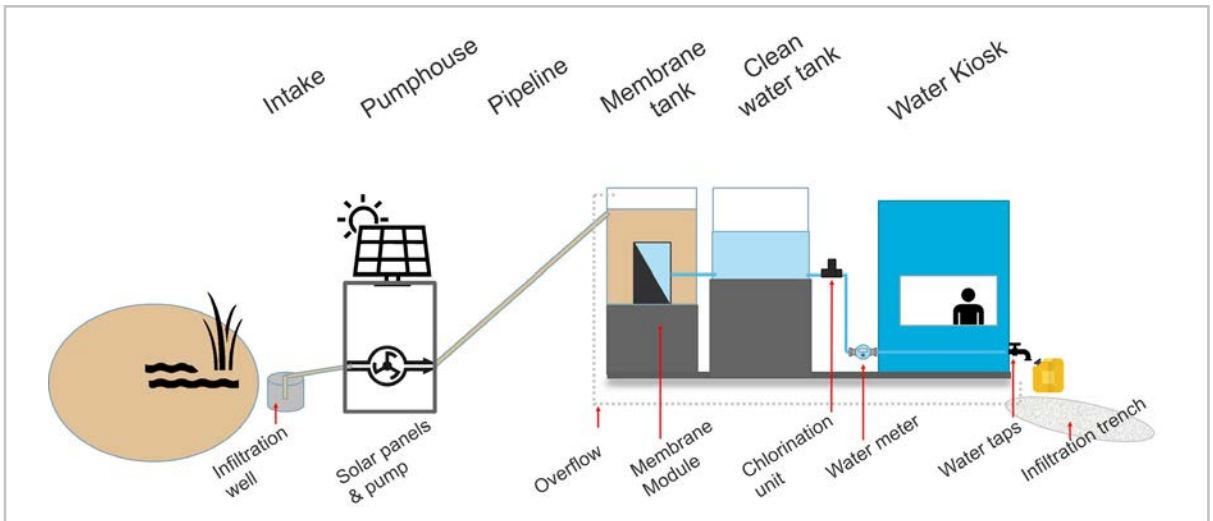

Figure 9: Horizontal GDM set-up of Uganda

Scan the QR code to watch the video "Showcasing a horizontal GDM treatment system" or go to <https://youtu.be/0IUUdmfQEJA>

**watch video**



Figure 10: Jerrycans lined up in front of a horizontal GDM water kiosk

# 1 Source: Lake water

In the areas, where the horizontal GDM systems were constructed in Uganda, the utilisation of groundwater is challenging as it has a high salt concentration and, therefore, is not suitable for human consumption. Lake Victoria, is used as an alternative water source. Many households consume the water directly without treatment. Even though the water is turbid, it can be treated in one step using GDM filtration. Water quality analysis of water from the Lake revealed that the water is highly contaminated with faecal and other coliform bacteria (E. coli: >300CFU/100ml, Total coliforms: >300CFU/100ml), has a high concentration of natural organic matter (Total organic carbon = 8.1 mg/L) a high turbidity (10 - 25 NTU, with peaks >150 NTU) and the oxygen levels gradually decline from the surface (6.2 mg/L) to the sediments (1.2 mg/L). The concentrations of metals measured (Ag, Pb, Cd, Ce, Cr, Mn, Fe, Ni, Cu, Zn, Co) were lower than the WHO Guideline values for drinking water. In addition to lake water, rainwater is collected from the nearby buildings and piped to the treatment system.

# 2 Intake: Site specific

Site specific designs for the construction of the intakes at the five locations were chosen on the basis of the quality of the raw water, the properties of the ground, the shore and other local circumstances. Three different types of intakes were installed.

## 2.1 Direct strainer intake

Due to the presence of floating vegetation and subsequent clogging, a direct strainer intake could only be installed at one site where a local harbour protects the submerged suction pipe and strainer from vegetation (see Figure 11). The intake could be attached directly at the pier. A 10micrometer mesh check valve strainer was used to protect the pump from larger particles that can damage the pump (see Figure 12). For additional protection, a perforated PVC pipe ("outer strainer") was installed around the strainer (see Figure 13). The intake was placed at a depth of at least 1 m, but with sufficient distance from the bottom, where the sediments and sand could increase the probability of clogging the strainer. The intake pipe should be located at a sufficient distance from the shore to reduce its susceptibility to turbidity fluctuations after rain events.



Figure 11: Harbour, where direct strainer intake was attached



Figure 12: Strainer

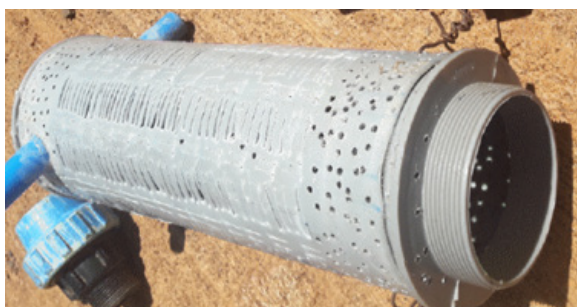

Figure 13: Perforated PVC pipe to protect strainer



Figure 14: Clogged strainer due to lacking maintenance

## 2.2 Infiltration well

An infiltration well, consisting of a dug well, was installed at a site with sandy soil and non-salty groundwater. The infiltration well uses the shore to naturally pre-filter the water. This intake type is robust, does not interfere with activities at the shore of the lake, does not swell during strong winds and is not disturbed by floating vegetation, as experienced in Lake Victoria. Two cement rings ("culverts") were buried in the sandy bottom and connected with water proof cement (see Figure 16). A cement lid covered the well (see Figure 17). Water entered from the bottom and through the lower cement ring that had holes (see Figure 15). It was important to build the intake high enough to avoid water entering directly from the lake surface into the well at high lake levels. It is recommended to build the intake approximately 20 - 30 cm higher than the maximum lake level observed. A 10micrometer mesh check valve strainer (see Figure 12) was placed around the opening of the intake pipeline connecting the intake with the pump to retain any remaining large particles and protect the pump.



Figure 15: Inside of the infiltration well made from cement rings



Figure 16: Scheme of an infiltration well



Figure 17: Picture of the pump house and the infiltration well (encircled)

## 2.3 Unprotected intake followed by roughing filter

The installation of a simple dug well was not possible at several sites due to soil with a high clay content that reduced soil permeability or because of the high saline content of the ground water. Therefore, roughing filters in direct contact with the lake were constructed. The structure of the dug well was similar to the infiltration well, but the section between the lake and the well was constructed, replacing the natural soil with gravel and sand. First, the pit needed to be excavated. After the cement rings were placed in the pit, the different sections of the filter were filled, starting from the cement rings (see Figure 18). The stones had diameters of ~ 10 - 40cm. The aggregates had diameters of ~ 1 cm. "Stone dust", a by-product of stone crushing, was used as a coarser replacement for sand. For further details about the construction of roughing filters, refer to (Wegelin, 1992).

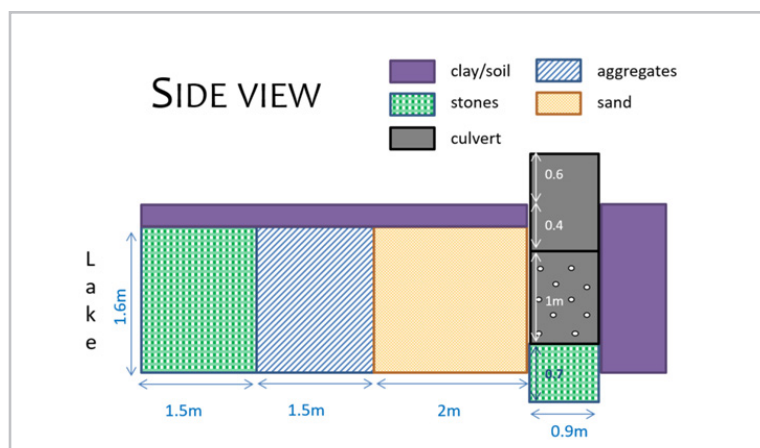

Figure 18: Possible design of an infiltration well with a roughing filter



## 2.4 Operation & maintenance

All types of intakes need to be regularly checked. The cement rings (culverts) need to be checked for cracks or accumulating sediments approximately every month. Cracks should be fixed or broken cement rings need to be replaced. Accumulated sediments need to be removed to protect the strainer at the suction point. Additionally, the strainer should be checked and, if necessary, cleaned on a regular basis. In the case of a direct intake into Lake Victoria without a well, it is recommended to clean the strainer approximately every two weeks using a brush to avoid clogging (see Figure 14). To do this, the strainer, which is located in a depth of about 1 m, is pulled out from the lake, and the perforated PVC pipe is cleaned and removed. Then, the strainer is cleaned using a brush. A manual for the cleaning of the strainer can be found in the Appendix B. In the case of a roughing filter, it might be necessary to replace the sand in the roughing filter after some years of operation. This should be done if the roughing filter is clogged with sediments and as a consequence, not enough water enters the well to meet the demand.

# 3 Abstraction: Solar pump

Accessibility to the power grid is very limited and unreliable in the area where the GDM water kiosks were installed. Therefore, a solution independent from power supply was chosen. As diesel generators have high operating costs and are not environmentally friendly, a solar pump was installed that uses the renewable energy of the sun (Ennos Sunlight pump, Figure 20, different models were installed at different sites). As mentioned in Part I, section 2.3, the Ennos pump is one option among a variety of products. The pump needs to fit the local context and factors such as the availability (of spare parts), costs, robustness, O&M requirements etc. need to be assessed. The Ennos pump only operates when energy is produced by the solar panels. The stronger the sunlight is, the more water is pumped. Flexible hoses connect the pump to the pipeline. On the suction side, the flexible hose is reinforced with a wire. One air release valve is installed to avoid the accumulation of air bubbles in the pressure pipe. Two check valves are installed to avoid emptying the suction and pressure pipes and ensure the pump functioning (see Figure 19).

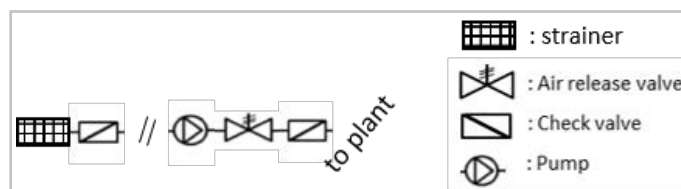

Figure 19: Plumbing of the solar pump

The pump needs to be fitted to the design parameters. In this case, the pump needs to overcome a total head (including the vertical displacement and friction in the pipeline) of 27 - 61 m and to pump a water volume of 4 - 7 m<sup>3</sup> per day.



Figure 20: Ennos Sunlight pump installation



Figure 21: Solar panel

Many different alternative pumps exist on the market. It is recommended to get advice from a local pump supplier, as the correct installation and a supply chain for spare parts are important. It is also worthwhile spending enough time on the pump selection process, as it is an important but also delicate part of the whole system. **!**

A high efficiency polycrystalline solar module with a maximal power output matching the requirements of the solar pump was installed to deliver electricity to the pump (see Figure 21). The panel was placed on a metallic structure on the top of the pump house (see Figure 22). This elevated location of the solar panel provided protection from vandalism and theft. MC-4 cables connected the pump to the solar modules. The maximum power output (pmax) under standard test conditions was 255 - 400 Watts, (this depends on the project site). This is enough to power the solar pump, which required 144 - 360 Watts.

### 3.1 Operation & maintenance

In theory, the Ennos solar pump needs little maintenance, as the motor is brushless. Depending on the raw water quality, the stator and rotor need to be exchanged after some years of operation. Biannual to annual maintenance include the inspection of the electrical board and switches, cables, and the motor. In our experience the pump needed to be serviced and repaired by trained personnel several times per year. A high sediment content in the raw water might have been the cause for the increased maintenance requirements.

Always follow the instructions of the manufacturer of your specific pump.

Depending on the season and location, it is recommended to clean the solar panels weekly to monthly with a clean and soft cloth and clean water. Soap, hard materials or dirty cloths should be avoided, as they can scratch the surface of the panel (see Figure 23). More frequent cleaning might be necessary. For example, at one site the excreta of birds contaminated the solar panels quickly, generating the need for frequent cleaning of the solar panel. If necessary, the surrounding trees need to be trimmed to avoid shading the solar panel.



Figure 22: Pump house



Figure 23: Instructions for cleaning the solar panel

Scan the QR code to watch the video "Maintaining the intake on a bi-weekly basis" of our series or go to <https://youtu.be/f65uUHrkGQ>



## 4 Treatment: GDM filtration

The GDM treatment site consists of the membrane tank, in which the ultrafiltration membrane modules are installed, the clean water tank and optionally a raw water storage tank. The tanks are installed on fundamentals and covered. Optionally, a roof over the treatment site can be installed. An infiltration trench is necessary to drain the excess water. Section 4.1 describes the different components of the GDM treatment site, section 4.2 explains the installation process and 4.3 the operation and maintenance procedures.

### 4.1 Description of components

#### 4.1.1 Membrane modules

Flat sheet membrane modules of Martin Membrane Systems GmbH (2x4 Aqua-Cubes, 4 Aqua-Cubes: 69 cm x 54 cm x 65 cm, see Figure 25) were used. Ultrafiltration membrane modules were installed, as sketched in Figure 24, and connected to each other using Martin Systems' standard connections (see Figure 26). A flexible tube was installed between the membrane module and the pipe through the tank. The relatively small size of the modules allows for flexible sizing and easy installation. The total membrane area was 80 m<sup>2</sup>. The membranes were made of polyethersulfonate (PES) with a nominal pore size of 20 - 40 nm.



Figure 25: Technical drawing of 4 Aqua Cube module

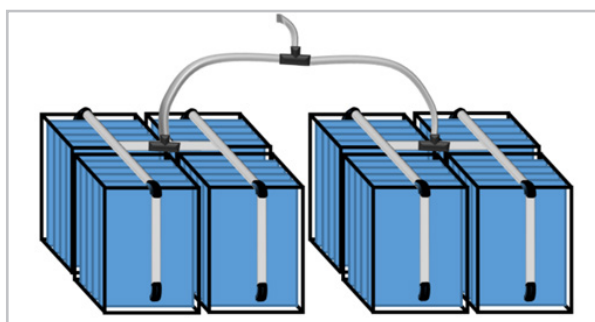

Figure 24: The arrangement of the 2x4 Aqua Cube membrane modules



Figure 26: Aqua Cube modules in the membrane tank



In the first kiosks, Bio-Cel® MBR 25 membrane modules (120 cm x 70 cm x 156 cm) of Microdyn-Nadir (Wiesbaden, Germany) were used with a membrane area of 75 m<sup>2</sup>. The membranes are made of polyethersulfonate (PES) with a nominal pore size of 40 nm.

Flat sheet membranes have more space between the membranes than hollow fibre membranes and therefore clog less. Hollow fibre membranes clog faster and should only be considered if the raw water is "clear" (low turbidity and few particles).

As an alternative to PES, polyvinylidene fluoride (PVDF) might be used. PVDF is resistant to drying, but needs to be activated prior to use and filtration performance is not as good as for PES. Recently developed PES membranes can better handle dry periods.

### 4.1.2 Tanks

Tanks for the storage of drinking water must be made of food grade material (NSF standard 61), such as plastic, stainless steel or concrete. It is important to investigate different price qualities, sizes and providers. Transport of the tanks to the construction site can be a significant expense of the total cost of the tanks. For the membrane tank, a 10m<sup>3</sup> polyethylene tank was used and placed on a fundament with a height of 1.3m. The membrane tank had an inlet, an outlet to the clean water tank, a flushing outlet at the bottom of the tank and an overflow (drilled into the walls). The clean water tank stored the treated water after filtration. A 6m<sup>3</sup>, cylindrical polyethylene tank was used and placed on a 1.8m high concrete fundament. The high fundaments are needed to have sufficient flow at the water taps. The tank had an inlet and an outlet with a gate valve. The clean water storage tank needs to be properly closed with a lid at all times to prevent the entrance of debris and dust (see Part IV, section 3). Both membrane and clean water tanks need openings on the top to make them accessible for installation and maintenance work. In terms of the tank material options, plastic is cost effective, widely available and easy to transport and install. Stainless steel on the other hand might be more durable, but also more expensive, heavier and susceptible to corrosion. If well built, concrete is the most durable material but also the heaviest and most difficult to install, as it needs to be built on-site.

Alternatively, concrete or stainless steel is also possible for the membrane tank or the clean water tank.

Furthermore, if larger water volumes have to be produced or if the raw water supply is irregular, adding a raw water tank and connecting it to the membrane tank, instead of installing the membranes in a large tank, can be considered (see Figure 27 & Figure 28). This increases the storage volume of raw water. Nevertheless, adding a raw water tank generates supplementary costs (i.e. the tank and the associated fundament). However, for maintenance and installation work, smaller tanks are generally easier to handle. When a solar pump is installed to supply the raw water to the water treatment site, having a raw water tank is a benefit because the maintenance procedure of the membrane tank (see section 4.3.1) does not rely on sunny weather and water from the pump, but raw water stored in the raw water tank can be used.

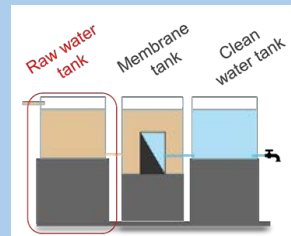

Figure 27: Three tank set-up with raw water tank

### 4.1.3 Fundaments

Reinforced concrete was used for the fundaments (see Figure 28). The fundaments have to carry heavy weight and need to be sufficiently fortified to prevent them from collapsing. For higher fundaments, constructed pillars were built to reduce the amount of concrete required. As an alternative to using a ladder, iron steps could be integrated in the fundament to ensure easy access. For the height of the fundaments, refer to section 4.2.



Figure 28: Fundaments of a three tank set-up



Alternatively, steel constructions for the fundamentals are possible.

#### 4.1.4 Infiltration trench

Wastewater is generated during the maintenance and flushing of the membrane tank and at the water fetching area. There could also be an overflow of the membrane tank (or, if present, at the raw water tank), if the solar pump delivers a volume larger than the tank. The excess water should be collected and piped to an infiltration trench (see Figure 29). There, the water can easily infiltrate into the ground. If the excess water is spilled on the ground without an infiltration trench, this can lead to swampy and muddy areas, which are unhygienic and potential breeding places for

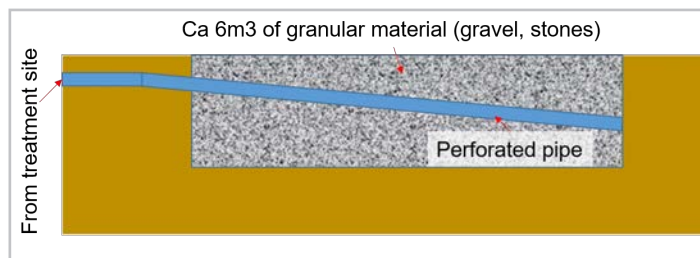

Figure 29: Infiltration trench

mosquitoes. An infiltration trench needs to be dug and filled with gravel or stones to have a fast infiltration to the ground. The infiltration trench is connected to the overflow pipes. The size of the infiltration trench depends on the volume of the excess water and the infiltration rate of the ground. The faster the water is able to infiltrate into the ground, the smaller the pit needs to be. In the described project, the pit had an area of 6 m<sup>2</sup> and was 1 m deep.

#### 4.1.5 Roof

A roof covering the entire treatment system is not necessarily. However, it can be useful to protect the tanks from the sunlight (and deformation) and the clean water storage tank from contaminants. The roof could also be used for rainwater collection. A roof can be made out of iron sheets, reeds or other local materials.

## 4.2 Installation of the membrane modules

This section focuses on describing the installation of the tanks and the ultrafiltration membrane modules. The installation of the other components of a GDM system (intake, pump, pipeline, fundamentals, infiltration trench and water kiosk building) are not specific to GDM water treatment and, therefore, are not included in the description. To install the tanks and the membranes, the water supply needs to be running (functioning intake, pump and pipeline) and the fundamentals have to be constructed. It is also recommended to install the tanks only after the distribution taps at the water kiosk and the infiltration trench have been established.

After testing that water reliably reaches the tanks of the treatment site, the installation of the membrane modules can begin. The modules are the most sensitive part and depending on the type of the membrane always have to be kept wet (at least 1/3 submerged)!

Preparations to install the membranes:

1. Place all the tanks in the planned position and mark the holes required for the connections
2. Make sure access to all tanks is provided. Iron steps in the fundamentals are the preferable option. Or else, ladders or another access to the tanks has to be present. The tanks need to be accessed for membrane maintenance, tank cleaning and disinfecting.
3. Drill the holes for the connections. Always leave 5-10cm between the bottom of the tank and the holes for inlets or outlets. Drill holes for overflows 20cm below the top of the tank (see Figure 30).
4. Install bulkhead adaptors where the holes are drilled. Brass metal bulkhead adaptors are recommended so that tightening does not strip the threads. A leak-proof seal of the bulkhead adaptors is important.

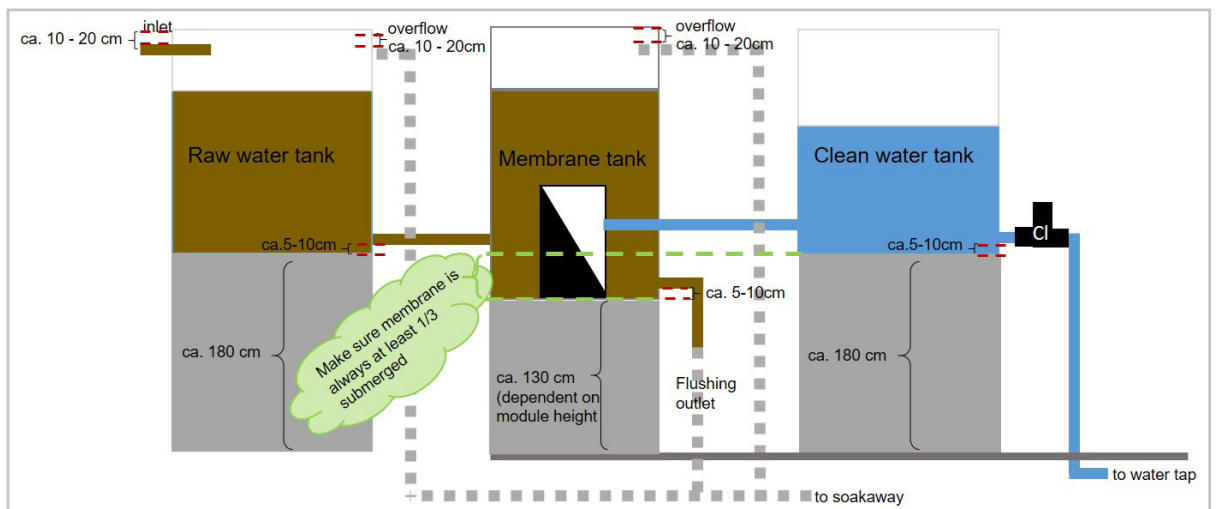

Figure 30: Drawing with the suggested position of pipe connections (horizontal three tank design)

5. In the two-tank design, connect the pipeline directly with the membrane tank. In the three-tank design, connect the pipeline with the raw water tank and the raw water tank with the membrane tank. Then, connect the water taps with the clean water tank and the overflows. For the connections, PE/PVC adaptors, union fittings, elbows and the necessary PE or PVC pipes will be required. Do not connect the clean water tank to the membrane tank until the membranes have been installed (steps 6 - 8)!
- Install gate valves at (see Figure 31):
    - » the outlet of the clean water tank
    - » between the clean water tank and the membrane tank
    - » the flushing water outlet of the membrane tank
    - » between the membrane tank and the raw water tank (if present)

- Install sampling valves (see Figure 31)
  - » between the membrane tank and the clean water tank
  - » between the clean water tank and the water taps
- It is recommended to install a water meter between the water taps and the clean water tank
- Connect the overflows to the infiltration trench

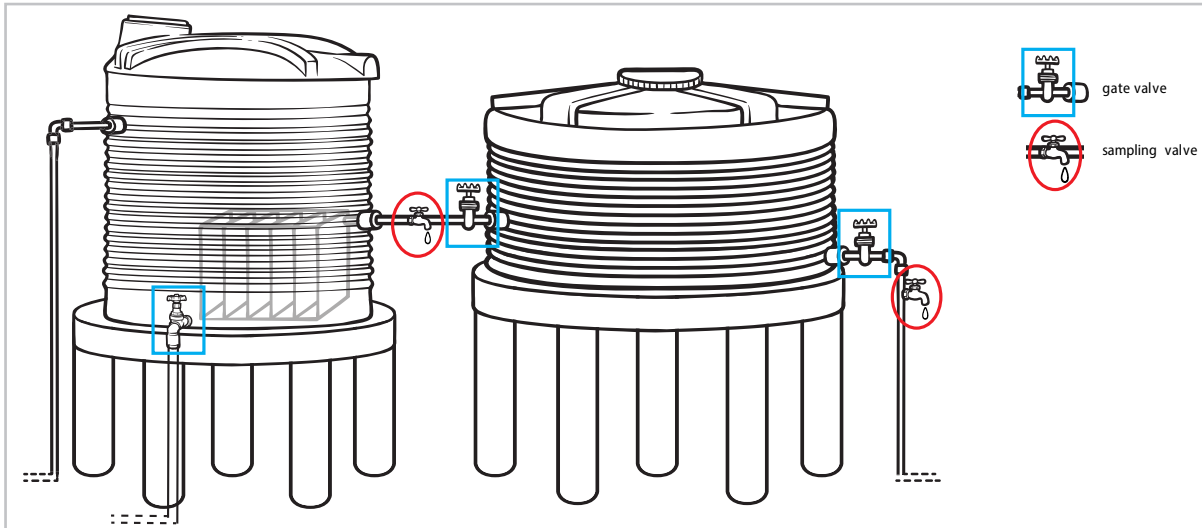

Figure 31: Overview of sampling valves and gate valves in two tank set-up

Now, the site is ready to install the membranes:

6. If PES membranes (see Part I, section 2.4.3) are used, flush and wash the membranes carefully with clean water. PES membranes are filled with glycerol for transport to keep them wet. Because glycerol contains a lot of nutrients, if it enters one of the tanks, it boosts the growth of bacteria and algae. Follow the instructions of the manufacturer.
7. If a raw water tank is present, fill it. If not, make sure that the raw water supply is running to be able to fill the membrane tank and submerge the membranes immediately after installation.
8. Place the flushed membrane modules inside the membrane tank and connect them to each other. Connect the modules to the outlet of the membrane tank.
  - » Handle the membranes with care, they are very sensitive. Never touch or scratch the surface of the membranes! Always follow the instructions of the manufacturer.
9. Connect the outlet of the membrane tank with the clean water storage tank. Install a gate valve and a sampling valve in between.
10. Fill the membrane tank.
  - » Make sure that the air trapped inside the modules is released. If they are not fixed at the bottom of the tank, put something heavy on the membranes to keep them from floating.
  - » Always follow the instructions of the manufacturer. Some membranes need to be kept submerged in water or at least wet (e.g. cover them with a plastic cover/tarpaulin) to avoid damaging them. PVDF and the latest PES membranes usually survive dry periods.



Before starting to use the GDM treatment site and distributing the drinking water to customers, check the performance of the system by a membrane integrity test and a water quality test (see Part V, section 1.2).



Scan the QR code to watch the video "Installation of the ultrafiltration module" of our series or go to [https://youtu.be/waRJOjL\\_y4](https://youtu.be/waRJOjL_y4)

## 4.3 Operation & maintenance

This section describes the operation & maintenance tasks for the GDM treatment site. It includes the monthly and yearly procedures required to maintain the membranes and a procedure to reduce recontamination risks in the clean water storage tank. A complete troubleshooting guide for the GDM water kiosks can be found in Appendix A. For more details about recontamination refer to Part IV, section 1.

### 4.3.1 Monthly flushing of the membrane tank

In the membrane tank, the particles and pathogens present in the raw water are retained on the membranes, or suspended in the water or settle to the bottom of the tank. Together with parts of the biofilm on the membranes, they should be flushed out once a month. This will increase the oxygen level in the tank and, therefore, will increase biological activity. Additionally, the biofilm load on the membranes is decreased. As a consequence, flushing the membrane tank will main-

- After flushing, refill the membrane tank immediately
- Never touch the membrane modules!

tain a higher level of the flux over an extended period of operation.

Flushing procedure with two tanks

1. Make sure that the raw water supply is secured to avoid drying out the membranes after emptying the membrane tank. If a solar powered pump is used to pump water from the source to the membrane tank, the procedure should be conducted in the morning on a sunny day to assure the smooth operation of the pump and to quickly refill the empty membrane tank after the flushing procedure.
2. Interrupt the raw water supply (shut down pump) and close the valve between the clean water storage tank and the membrane tank.
3. Open the flushing valve at the bottom of the membrane tank to empty the tank completely (see Figure 32). The flushing out of water will remove parts of the biofilm attached to the membranes and will also flush out sediments accumulating at the bottom of the tank.
4. Close the valve at the bottom of the membrane tank and start the raw water supply again to fill the membrane tank again.
5. After the membrane modules are again covered with water, open the valve between the clean water tank and the membrane tank.

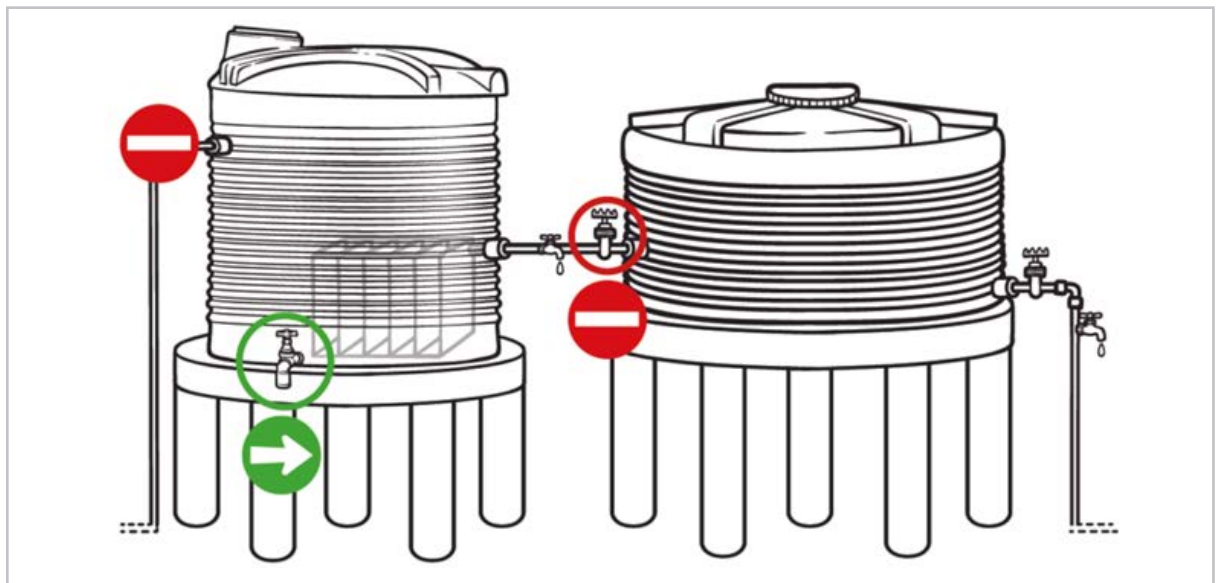

Figure 32: Flushing of the membrane tank



Procedure with three tanks (see Appendix B for illustrations)

1. Make sure that the raw water storage tank is full (or at least 3/4 full) to have water available to refill the membrane tank after flushing and therewith avoid drying out the membranes.
2. Close the valve between the clean water storage tank and the membrane tank AND the valve between the raw water storage tank and the membrane tank.
3. Open the flushing valve at the bottom of the membrane tank and completely flush out the water from the membrane tank. The flushing out of water will remove parts of the biofilm attached to the membranes and will also flush out sediments accumulating at the bottom of the tank.
4. Close the valve at the bottom of the membrane tank and open the connection between the raw water tank and the membrane tank to refill the membrane tank again.
5. Open the valve between the clean water tank and the membrane tank after the membrane modules are covered (~ 1 hour).



Scan the QR code to watch the video “Maintaining an ultrafiltration membrane on a monthly basis” of our series or go to <https://youtu.be/Wv8pVe5debc>

#### 4.3.2 Yearly check-up by trained personnel

Once per year or if water quality monitoring procedures reveal contamination in the system that cannot be removed with disinfection of the clean water tank (see below), it is highly recommended to do a general check-up of the membrane modules. This procedure involves checking all connections, screws and the state of the modules.

1. Close all the valves between the clean water storage tank and the membrane tank. Interrupt the delivery of raw water to the membrane tank (close the valve between the membrane tank and the raw water tank if you have a system with three tanks).
2. Open the valve at the bottom of the membrane tank to flush out all the water.
3. Remove sediments from the bottom of the membrane tank by using a brush or broom, sponges or cloths and a jerrycan. Be careful to not damage the membranes while cleaning the membrane tank!
4. Check the connections of the membrane module. Are they tight? Are hose clamps rusty? Are the screws tight?
5. Change rusty or damaged parts if necessary and tighten all the screws.
6. Close the valve at the bottom of the membrane tank and refill the membrane tank with raw water (if you have a system with three tanks, open the valve between the membrane tank and the raw water tank to refill the membrane tank).
7. After the membrane modules are covered, open the valve between the membrane tank and the clean water tank.
8. It is recommended to perform a membrane integrity test after the yearly check (see Part V, section 1.2)



Scan the QR code to watch the video “Conducting a yearly service of the ultrafiltration membrane” of our series or go to <https://youtu.be/Jfr4QJHaJJA>

### 4.3.3 Monthly disinfection of the clean water storage tank

To reduce recontamination risks in the clean water tank and in the pipes between the tank and the taps, a cleaning and disinfection procedure should be carried out once a month:

Procedure (see manual in the Appendix B for illustrations):

1. Check that the water level in the clean water tank is at least 1/3 full.
2. Prepare all the things needed: a spanner, a jerrycan, a 0.5L PET bottle and a 90 % chlorine concentration powder (available as bleaching powder or swimming pool disinfectant)
3. Close the valve between the membrane tank and the clean water tank.
4. Add 100g of chlorine powder to a jerrycan and fill it with clean water. To measure 100g of chlorine, cut a 0.5L PET bottle, turn it around and fill it to 4 cm (see Figure 33)

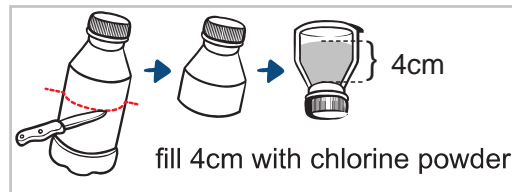

Figure 33: How to measure 100 g of chlorine powder with a 0.5L PET bottle

5. Pour the jerrycan with the chlorine solution into the clean water tank (see Figure 34)
6. Wait at least three hours for the disinfection to be effective
7. Mix the water in the tank with a stick and slowly start flushing water through the tap (~ 1 hour)
8. Flush out all the water and empty the clean water tank.
9. Open the valve between the membrane tank and the clean water tank to refill the clean water tank.

- Be careful when handling chlorine. Contact of concentrated chlorine solution with skin or eyes will cause damage to your skin or eyes. If your skin or eyes get into contact with a concentrated chlorine solution, immediately wash it away with a lot of water.
- Wear gloves and goggles when working with concentrated chlorine and keep children away!
- Note: Some membranes can be affected by chlorine (refer to the instructions of the manufacturer). If this is the case, never put any chlorine into the membrane tank or the raw water tank.

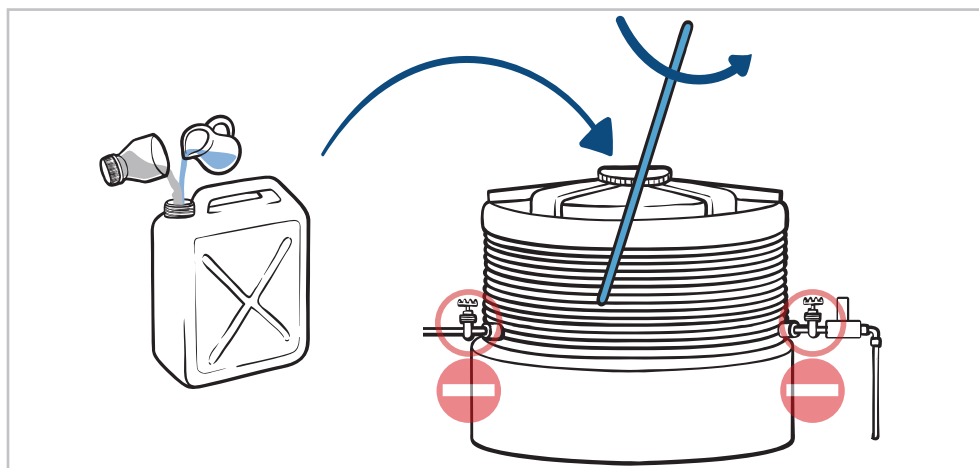

Figure 34: Pour the jerrycan with the chlorine solution into the clean water tank

Scan the QR code to watch the video "Maintaining a clean water tank on a monthly basis" of our series or go to <https://youtu.be/aPLq2QyU-28>



## 5 Distribution and transport: Water kiosk and jerrycans

The water in the GDM water systems in Uganda was sold directly at the kiosk building. With pay per unit or monthly subscriptions, water was sold to customers who come and fill their 20L jerrycans at the kiosk. After filling, customers carry their water containers home (see Figure 37). At the water kiosk building, the water was distributed via taps (see Figure 36). The inside of the building was accommodated with shelves to store additional products for sale (see Figure 35), tools and documentation. The total building was 5m long (3m inside room and 2m terrace with roof for water sale) and 2m wide. Pipes with a diameter of 20mm ( $\frac{3}{4}$  inch) were connected to four lockable taps for water distribution.

Automatic water vending machines were installed (see Figure 38), which release a predefined amount of water upon tapping a near field communication (NFC) token with sufficient credit. The water released is logged and can be monitored on an online dashboard. This increased transparency of cash flow, as well as water consumption, and made the water accessible during 24 h. This installation requires professional support and a local salesman needs to be trained to operate and maintain the vending machine. Investment costs for the automatic vending machine are substantial, but it usually pays for itself over time due to improved accountability and service quality.

A fence around the water treatment site helps to keep animals away. The operator in charge of the facility is responsible to keep the area around the water kiosk tidy and clean. If an automatic vending machine is installed, the operator recharges water tokens and takes care of smaller issues. Trained technicians are responsible to solve larger issues and repair the system in case of a break down.



Figure 35: Shop items



Figure 36: Water kiosk building



Figure 37: Carrying water



Figure 38: Automatic water vending machine (Water ATM)

# 6 Lessons learnt from practice

The following recommendations for the sustainable operation of GDM water kiosks (see Table 9) are based on five years of managing GDM water kiosks for water treatment at community scale in remote areas at the shore of Lake Victoria. The information presented is based on technical performance assessments and contains the experiences of management committees, operators and users collected during focus group discussions and personal interviews.

Table 9: Lessons learnt from practice

Technical aspects	
<u>Intake</u> : High turbidity and particles in the raw water can clog the strainer and damage the pump.	Carefully assess the turbidity and sediment content in the raw water and, if necessary, take measures (roughing filter or other pre-filtration mechanism) to reduce them at the intake and to preserve the pump.
<u>Pump</u> : The pump was the most sensitive component of the GDM water treatment system and could break down due to lack of maintenance, too turbid raw water or flooding.	Install a functioning pre-filter if necessary (Part II, section 2) and carefully train local mechanics in pump maintenance and repair procedures. Also, make sure there is a supply chain for spare parts of the pump and access to maintenance service.
<u>Tanks</u> : Large tanks (10 m <sup>3</sup> or larger) can be difficult to access for installation and maintaining the membranes. Furthermore, the tops of wide tanks of low quality could collapse.	<ul style="list-style-type: none"> <li>- For large tanks, proper ladders are required to climb into the tanks.</li> <li>- Tanks with a diameter of 2.5m required metal enforcements to prevent the tops from bending downwards</li> </ul> 
<u>Clean water tank</u> : Recontamination	Always keep the clean water tank covered with a proper lid to keep out contaminants and regularly clean and disinfect the clean water tank (see Part II, section 4.3.1).
Kiosk building	In retrospect, our kiosk building was too large. A simpler and smaller construction would have served the purpose.
Recontamination in users' containers during transport and storage	Chlorination of the water after the filtration step is advised. Free residual chlorine prevents recontamination (see Part IV, section 1). In addition, the use of clean and disinfected safe storage containers are an effective measure to prevent recontamination.

<b>Consumer perspective</b>	
<u>Water price</u> : if a more economical alternative is available, customers probably will not use your source.	Be aware of the price of water at other local sources. If the price is lower but the water unsafe, start a campaign to raise awareness of the importance of consuming safe water. Introduce monthly payment plans or memberships to have loyal customers.
<u>Opening hours</u> : if opening hours are not adapted to the local customs, or water is not regularly available, people will not fetch water at your treatment plant.	Adjust the opening hours to your customers' needs, provide regular opening times and a reliable water supply. An automatic prepaid water tap (water ATM, see Part II, section 5) guarantees reliable access to water for 24 h per day. Studies have shown that providing reliable access throughout the whole day increases the number of regular customers and reduces waiting time at the kiosk.
<b>Management and Business perspective</b>	
Financially sustainable business model	It is challenging to run a financially sustainable water kiosk in remote communities with people who have limited financial means and where there is a low customer density. Additionally, installation and service costs are high in remote areas. Invest in elaborating a realistic business model (see Part V, section 2). If user fees are not enough to cover the expenses, think of additional potential income sources, such as involving the government to subsidise the operation or selling additional products.
Poor leadership and ownership by the kiosk committee.	If your project is community-centred, make sure that you have highly motivated community people involved. Adequate incentives for people managing and operating the system (salary and prestige) need to be present. To increase ownership, let the community participate in the planning process, but also oblige them to contribute with their own means (see Part V, section 3.4). Furthermore, it is important to develop the required capacity for business management.
Unethical behaviour by the responsible community members (i.e. misappropriation of resources).	A technical solution to monitor water sales is an automatic water tap with cards permitting prepaid mobile money payments. Apart from digital solutions, multi-signatory accounts and the obligation to regularly share the balance with the users can reduce unethical behaviour.
Lack of local skills and capacities	Sustainable operation of a GDM water treatment system is only possible if the technical as well as the management skills required to locally run the system are available among the members of the water management committee and system operators. Assure that the corresponding training and capacity development activities are carried out and that refresher trainings are conducted.

## Part III: Vertical GDM example



After extended tests at laboratories in Switzerland, the Eastern Switzerland University of Applied Sciences (OST) in collaboration with the Bowier Trust Foundation Switzerland (BTFS) team in Monrovia, implemented a vertical GDM system at the suburb of Monrovia in May 2019. The system was installed next to a church and a school with 320 pupils. This section of the guide describes the vertical GDM technology that was installed in Liberia. By end of 2021, a second vertical GDM system was inaugurated in the suburbs of Monrovia.

The GDM treatment site consisted of the raw water tank, the membrane tank, in which the UF modules were installed, and the clean water tank. The tanks were installed on a concrete tower. In Figure 39 and in Figure 40, a schematic overview and a photograph of the set-up are presented.

Table 10: Key figures of the vertical GDM example in Liberia

Membrane surface	10.5 m <sup>2</sup>
Tank volumes	Raw water tank: 4 m <sup>3</sup> Membrane tank: 2 m <sup>3</sup> Clean water tank: 2 m <sup>3</sup>
Max. Daily water production	4 - 5 m <sup>3</sup>
Nr of households supplied	100
Average water demand	Groundwater
O&M requirements	- Clean solar panels regularly - Flush the membrane tank monthly - Disinfect the clean water tank monthly - Yearly check-up of membrane modules
Pump input	750W, 220 - 240V

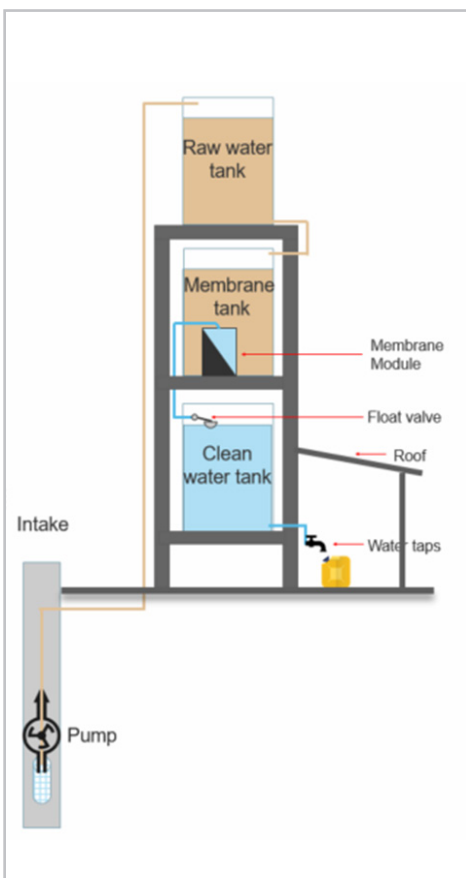

Figure 39: Vertical GDM scheme



Figure 40: Picture of vertical GDM treatment system

# 1 Source: Groundwater

The treatment site was located 100m away from the wetland of a river delta and approximately 550m away from the sea. The water source was groundwater from the wetland. It was microbiologically contaminated with >300 CFU of *E. coli*/100ml. The pH was 5.3 - 7 and the conductivity was measured at 100 - 450  $\mu\text{S}/\text{cm}$ . Iron levels of up to 0.5mg/l were detected. Other heavy metals (Arsenic, Cadmium, Copper, Nickel, Zink) could not be detected.

# 2 Intake: Infiltration well

Water was collected in a 30m deep groundwater well with a plastic coat (3 inch diameter, see Figure 41). The well was protected at the surface with a cement ring and a metal flap (see Figure 42).



Figure 41: Groundwater well with plastic coat (blue)



Figure 42: Groundwater well

# 3 Abstraction: Electric pump

An alternating current (AC) pump was installed at 25 m to abstract the water and pump it to the raw water tank. The height difference to the inlet of the raw water tank was 35 m.

The submersible borehole pump (model: 3XRm3/21-0.75, LEO Group, rated power: 0.75kW, single phase motor) had a flow rate of around 4.8m<sup>3</sup>/h. Electricity for the pump was provided by solar panels. The direct current from the solar panels was inverted (hybrid inverter, RG-MH 3200W Series) to alternating current (AC, 220-240V/50Hz) for the pump. Besides the pump, AC was also available for the church and security lights (see Figure 43). A battery package (4 x 250 Ah Raggie solar battery) provided electricity if the panels did not produce energy. Fuses protected the system from damages by surges. In total, eight solar panels (Monocrystalline Raggie, RG-M330, 330W) were mounted on the roof of the nearby church.

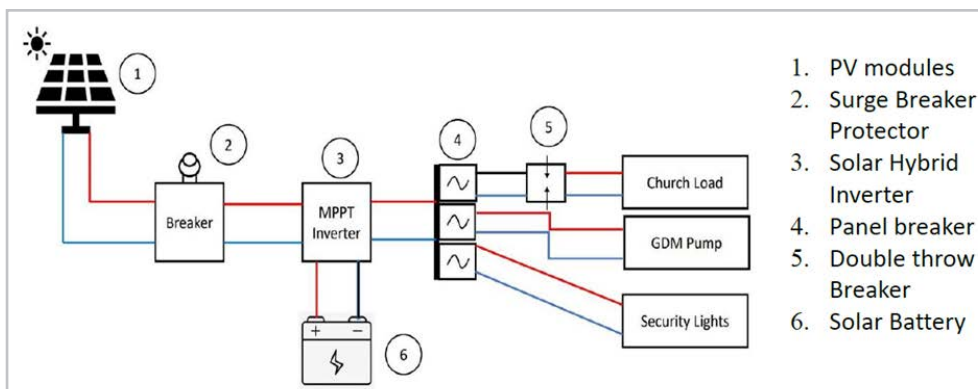

Figure 43: Electric scheme of the vertical GDM system in Liberia



## 4 Treatment: GDM filtration

### 4.1 Membrane modules

Three TDS-MC-MCXS2 flat sheet modules of Newterra GmbH Microclear in Germany were used (Figure 44 and Figure 45) with each 3.5m<sup>2</sup> membrane surface area, adding up to 10.5m<sup>2</sup> total membrane area. The membrane was made from Polyethersulfone (PES) and had a nominal pore size of 40 nanometres.

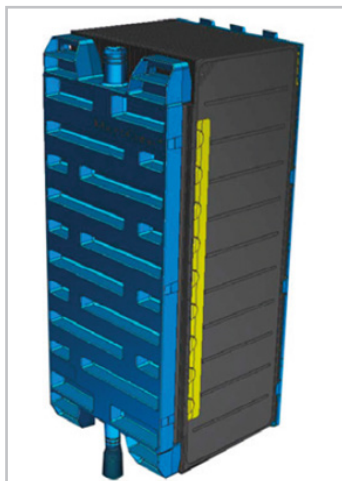

Figure 44: TDS-MC-MCXS2 membranes



Figure 45: Three TDS-MC-MCXS2 membrane modules installed in Liberia

### 4.2 Tanks

Cylindrical polyethylene tanks were installed on a concrete tower. The raw water tank had a volume of 4 m<sup>3</sup>, the membrane tank 2 m<sup>3</sup> and the clean water tank 2 m<sup>3</sup>. The raw water tank was positioned at the top level with a pipe connecting to the groundwater well. The outlet of the raw water tank was connected to the membrane tank. The treated water flowed from the membrane tank via the membrane modules to the clean water tank. At the inlet of the clean water tank, a float valve stopped the clean water tank from overflowing.

### 4.3 Fundamentals

The tower was made of reinforced concrete. The first floor of the tower was about 1.6m high, the second floor of the tower around 3.1 m and the third floor around 7m. Before the GDM installation, the tower was also used as a water tower, but did not contain a treatment system.

## 5 Distribution and transport: Water taps and jerrycans

The taps were installed 0.7m below the clean water tank to have sufficient pressure at the taps. The water in the GDM water system in Liberia was directly sold at the water taps (see Figure 46). Customers paid per container filled at the tap of the treatment station. After filling, customers carried their water containers home.



Operation & maintenance tasks for the horizontal GDM system and the vertical GDM system are identical. Please consult the maintenance recommendations presented in Part II of this guide. Additional instructions for maintenance procedures are presented in Appendix B.



Figure 46: Water taps at the vertical GDM system in Liberia

## 6 Other GDM applications

Apart from the vertical and horizontal GDM configurations described in this guide, several other GDM applications have been tested by various institutions. The following list gives an overview of them at the time of the publishing of this guide:

- Berlin Center of Competence for Water: A community-scale pilot study using GDM filtration (Boulestreau et al., 2012)
- Bowier Trust Foundation Switzerland ([www.bowier-trust.org/en](http://www.bowier-trust.org/en)): [https://www.bowier-trust.org/wp-content/uploads/2022/02/Technical-Report-E-with-Pics\\_14.2.2022-Kopie.pdf](https://www.bowier-trust.org/wp-content/uploads/2022/02/Technical-Report-E-with-Pics_14.2.2022-Kopie.pdf)
- Eawag - Swiss Federal Institute of Aquatic Science and Technology: GDM water kiosks (<https://www.eawag.ch/en/news-agenda/news-portal/news-detail/ultrafiltration-ohne-druck-mit-vielen-wassern-gewaschen/>)
- Gravit'eau Association for Handwashing: (<https://www.graviteau.ch/>)
- Eastern Switzerland University of Applied Sciences, GDM systems of different scale. ([https://www.umtec.ch/index.php?id=6652&L=0&content=20160&id\\_project=2879](https://www.umtec.ch/index.php?id=6652&L=0&content=20160&id_project=2879))
- Singapore Membrane Technology Centre: GDM as pre-treatment for reverse osmosis seawater desalination (Wu et al., 2017)
- Skyjuice Foundation: SkyHydrant™ Water Filtration Systems (<https://www.skyjuice.org.au/>)
- University of British Columbia: Passive membrane filtration (Jain, 2019)
- University of Kassel: PAUL® station, community scale (<http://waterbackpack.org/>)
- Vestergaard: LifeStraw® Community (<https://www.lifestraw.com/>)

## Part IV: User safety



If the water treatment is effective, the water is safe at the point where it is handed over to the customer. However, many studies revealed a high likelihood of water being recontaminated during transport to and storage at the household level under hygienically difficult conditions (Wright et al., 2004, Mellor et al., 2013, Opryszko et al., 2013, Meierhofer et al., 2017, Meierhofer et al., 2018, Gärtner et al., 2021). Figure 47 illustrates the results found in Uganda by Meierhofer et al. (2017). Even though the samples were free from contamination after GDM filtration at the water tap, significant recontamination could be observed after 24h of storage in jerrycans (left). If the water was chlorinated after GDM filtration, no recontamination could be observed except for some outliers (right). Studies show that it is necessary to take additional measures to assure treated water stays safe until the point of consumption. This part highlights the measures that should be taken to keep the water safe between the point of collection and the point of consumption. First, potential risks for recontamination are explained and then two strategies to reduce recontamination risks are presented.

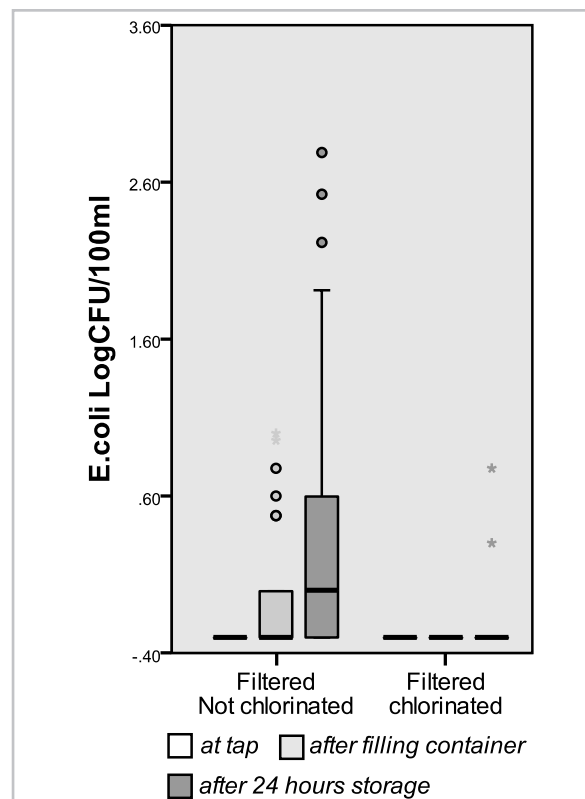

Figure 47: Recontamination at the household level in unchlorinated water (Meierhofer et al., 2017)

Scan the QR code to watch the video “Recontamination risks” of our series or go to <https://youtu.be/h5nMZcPfa64>



# 1 Recontamination

When water is stored in a reservoir, the risk of recontamination of previously safe water arises. Recontamination describes a process, during which water that was treated and free of contamination is contaminated again due to getting into contact with contaminated materials. Pathogens attached to leaves, dust, dead animals and other objects may get into contact with the treated water in the safe storage tank. In addition, nutrients present in the water can enable biological growth, including the potential regrowth of certain pathogens. They also support the growth of biofilm at the container wall that harbours bacteria, including pathogens. Regrowth can be reduced by restricting the conditions of growth (removal of nutrients from the water and storage of the container in a cool place).

Many factors affect recontamination, but generally speaking, the longer the water is stored, the higher the risk of recontamination. In a water supply system with GDM, there are two locations where water is stored and exposed to recontamination risks: in the clean water tank and in the household container. After filtration, the treated water is stored in the clean water tank before it is distributed. In a kiosk set-up, the users collect the water in a container to carry the water to their homes and store it until consumption. These containers pose a particular recontamination risk. The containers are often not clean and biofilms grow on the walls that contain pathogens, which are transferred in the water. Pathogens may also be transferred directly into the container if contaminated tools or objects, such as cups, or ladles, or dirty hands, are used to withdraw water. Strategies to lower the risk of recontamination in water storage containers are described in the following.



**Recontamination:** previously contamination-free water is polluted again due to contact with contaminated materials (via biofilms, openings, sediments, etc.).

**Re-growth:** Pathogens in water that has not been completely disinfected, encounter optimal growth conditions (nutrients and optimal growth conditions), which enables them to multiply.

# 2 Chlorination

Chlorination can be applied to add residual disinfection to the water and therefore prevent recontamination during distribution and storage of the treated water. WHO (2017a) recommends a free residual chlorine (FRC) concentration of 0.2 - 0.5 mg/L at the time of consumption and a minimum Ct value of 15 min\*mg/L. The Ct value is the concentration of a disinfectant (e.g. chlorine) multiplied by the contact time with the water being disinfected. A Ct value of 15 min\*mg/L corresponds to a contact time of at least 30 min with a residual chlorine concentration of  $\geq 0.5$  mg/L, whereby the pH value of the water is below 8. It is essential to adjust the chlorine dosage to the local situation. Temperature, the organic matter content of the source, cleanliness of the storage container or pipe network and other parameters influence the FRC concentration required (WHO, 2017b). Several field studies indicated that FRC concentrations of up to 2 mg/L may be required at the point of collection to protect water from recontamination in a remote rural context (Meierhofer et al., 2019, Gärtner et al., 2021). Too high FRC concentrations may not be accepted by the



A chlorination step prevents recontamination of previously safe water.



For further information regarding chlorination in small-scale water supplies, refer also to the publication "Principles and practices of drinking-water chlorination: a guide to strengthening chlorination practices in small-to medium sized water supplies" by the WHO (2017b).

consumers due to taste alterations and too low FRC concentrations may not prevent recontamination. Another risk of too high FRC concentrations are disinfection-by-products (DBP). DBP are formed when chlorine or other disinfectants interact with natural organic matter (NOM) in water and are potentially carcinogenic. As GDM reduces NOM in the water (Pronk et al., 2019) the formation of DBP from chlorine is reduced as well. In low-income contexts, chlorine usually is applied in liquid or solid form. It can be added centrally at the treatment site or at the household level. In larger distribution systems, it can also be added to the distribution system itself. It is recommended to chlorinate the water centrally to circumvent the need to establish point-of-use chlorination practices at the household level. Besides chlorination, there exist also other household water treatment technologies to treat recontaminated water. However, the outstanding advantage of chlorination is the residual protection of the water by free residual chlorine.

## 2.1 System level



Figure 48: T-chlorinator installed after the clean water storage tank

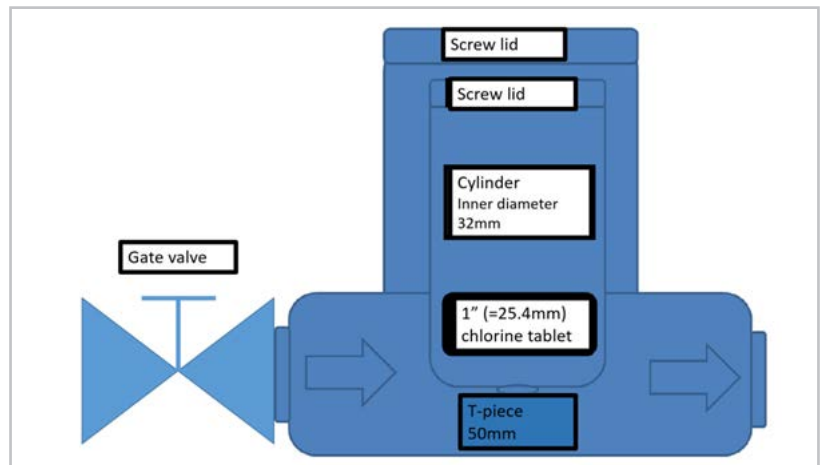

Figure 49: Scheme of a T-chlorinator

It is recommended to install a passive in-line chlorine dosing device after the clean water tank or at the point of distribution. An automatised chlorination step at the system level is more likely to assure the regular chlorination of the water and circumvents the challenge of establishing adequate individual chlorination practices at the household level. To operate a chlorination solution that is integrated into the system, the kiosk management and operator have to be trained on how to refill the chlorinators. A challenge for the GDM set up is to find a device that can be operated without electricity at the low flow rates and low pressure available in the GDM systems. In a recent study, several options for the GDM set-up were evaluated (Dössegger et al., 2021). The T-chlorinator performed best in GDM systems in terms of dosing consistency, user-friendliness, durability, and cost effectiveness. The T-chlorinator was installed in-line after the clean water tank (see Figure 48). A scheme of the T-chlorinator is presented in Figure 49. Chlorine tablets were inserted into the chlorinator and slowly eroded in the water flow. Detailed instructions on how to construct a T-chlorinator with locally available materials are presented in the Appendix C.

### Operation instructions for the T-chlorinator :

1. Close the gate valve.
2. Fill the cylinder with 1 inch size, slowly dissolving chlorine tablets (Trichloro Isocyanuric Acid Tablets, TCCA).
3. Close the lid of the cylinder.
4. Place the cylinder inside the T-chlorinator and close the lid.
5. Open the gate valve.

If water is not flowing through the chlorinator for more than 30 minutes (for example in the night or during membrane maintenance procedures), close the gate valve and let the water drain in the

pipe AFTER the T-chlorinator. This is to avoid high chlorine concentrations in the standing water. Alternatively, remove the cylinder during still stands of the water treatment system and put it back once the water is flowing through the system again. Refer to Appendix C for more details.

Possible alternatives to the T-chlorinator are presented in Figure 50 and compared in Table 11. A detailed analysis of the chlorinators is provided in Dössegger et al. (2021).



Figure 50: Alternatives to a T-chlorinator. From top left to bottom right: Floater, AquatabsFlo®, Venturi doser, Chlorine dosing bucket (CDB), Akvotur, Chlorine dispenser

Table 11: Alternative chlorination options (adapted from Dössegger et al., 2021)

Device (installation)	Description
<p><b>Floater</b> (Clean water tank)</p> <p>Multiple manufacturers (e.g. Intex Recreation Corp, California)</p>	<p>A floater floats in the clean water storage tank. Slowly dissolving TCCA chlorine tablets (size <math>\varnothing = 3</math> inch) are placed into the device and dissolve in the water. Opening or closing the slits at the bottom of the floater, as well as changing the number of tablets and the number of floaters in the tank, allow for adjusting the dosage. The device is widely available, robust and low-cost. However, a back flow of chlorinated water from the clean water tank to the membrane modules needs to be avoided to protect them from damages. Consistent dosing using a floater is challenging.</p>
<p><b>T-chlorinator</b> (In-line)</p> <p>Adapted from Orner et al. (2017)</p>	<p>The T-chlorinator consists of a cylinder with small holes that is placed into a T-fitting. It is installed in-line between the clean water tank and the kiosk's tap. The cylinder contains chlorine tablets (size <math>\varnothing = 1</math> inch), which are eroded by the flow of water. To adjust the dosage, the number of tablets can be altered. Alternatively, different cylinders with different amounts and sizes of holes can be manufactured and can easily be exchanged. The device can be locally made (see Appendix C), is low-cost, provides consistent dosing and is easy to operate and maintain.</p>

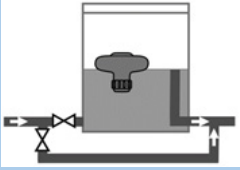
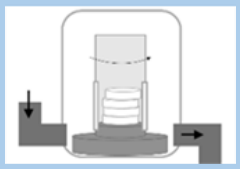
Device (installation)	Description
<p><b>Chlorine-dosing bucket (CDB)</b> (In-line)</p> <p>Design by Eawag</p>	<p>The CDB is an air-tight closed bucket (30L) with a bypass pipe that can be installed in-line after the clean water tank. A floater (see above), containing chlorine tablets (size <math>\varnothing = 3</math> inch), is placed inside the bucket. Valves at the inflow of the bucket and the bypass regulate the proportion of water passing through the CDB versus the bypass pipe and thereby regulate dosing. The higher the proportion of water passing through the bucket, the higher the chlorine concentration. Compared to the Floater, using the CDB prevents a back flow of chlorinated water to the membrane module and the device allows more consistent dosing.</p> 
<p><b>Venturi doser</b> (Tap)</p> <p>Mountain Safety Research (MSR, 2017)</p>	<p>The Venturi doser uses the Venturi effect for chlorine dosage. Water passes from a pipe with a large diameter to a pipe with a smaller diameter. This leads to an increase in flow velocity, while the static fluid pressure decreases. The pressure difference at the constriction causes liquid chlorine to be “sucked in”. The Venturi doser needs to be operated end-of-pipe and, therefore, needs to be installed right before the tap. A 1.2 % NaOCl solution was used to refill the device. A needle valve that restricts the flow regulates the dosing. A minimum flow rate of 6L/min is needed for the Venturi doser. The apparatus is robust and easy to operate and NaOCl is easily available. However, the device is in a prototype state and rather expensive (Cost estimation of MSR if the device is mass produced: 150USD).</p>
<p><b>AquatabsFlo®</b> (Tap)</p> <p>(Manufactured by Medentech in Ireland)</p>	<p>Water flowing through the AquatabsFlo® dissolves chlorine tablets placed inside the cartridge. The device can be installed after the tap with a bayonet catch for easy removal. The concentration can be adjusted with a screw, restricting the outflow, and thereby increasing the contact time with the chlorine tablets. In disagreement with others (Pickering et al., 2019), we sometimes observed difficulties with constant dosing. Also, the device is fragile. Tablets are not sold separately; thus, the entire device is replaced if the chlorine is used up. Compared to other devices, it is a rather expensive option (~0.22USD/m<sup>3</sup> at 2 mg/L free residual chlorine). However, installation and handling is very easy.</p>
<p><b>AkvoTur</b> (Tap)</p> <p>Design by Eawag</p>	<p>Similar to the AquatabsFlo®, the device is installed after the tap. At the bottom of a container (ca. 1 L, not airtight), a PVC plate is fixed, on which a PVC pipe can be placed. The pipe has two 2-mm slits. Water enters through one slit, erodes the TCCA tablets (size <math>\varnothing = 1</math> inch) inside and leaves through the opposite slit. To adjust the dosage, the PVC pipe can be turned. The more the slits face in the direction of the flow, the higher the chlorine concentration. The device can be made locally (see Appendix D) and is low-cost. Compared to the AquatabsFlo, dosing can be adjusted more flexibly. The device is not very robust and exposed to damages, if fixed at the tap.</p> 
<p><b>Chlorine dispenser</b> (Free standing dispenser)</p> <p>Evidence Action (Ahuja, 2017)</p>	<p>The chlorine dispenser is a container with a ball valve, filled with liquid chlorine. It can be located next to the water kiosk building. Customers place their 20L jerrycan filled with water below the dispenser and turn the ball valve to add chlorine to the jerrycan. One turn releases 3ml of a 1.2 % NaOCl.</p> <p>The principle is easy, the device very robust, NaOCl is easily available and the dosing consistency is fair. Its main challenge is the need for behaviour change among the users. Establishing a consistent practice to chlorinate the water has been found to be difficult (Yates et al., 2015).</p>
<p><b>WaterGuard/ Aquatabs</b> (Household level)</p>	<p>Liquid chlorine (NaOCl) or quickly dissolving Natriumdichloroisocyanurate (NaDCC) tablets are widely used to chlorinate water at the household level. Chlorine tablets or liquid chlorine are added to a 10 or 20L container. Whereas dosing consistency is high (especially for the tablets), a consistent application by the users has been found to be difficult (McLaughlin et al., 2009, Levy et al., 2014). Liquid chlorine (NaOCl) evaporates and decays if exposed to heat. Even in a tightly closed opaque bottle, stabilised NaOCl has a recommended shelf-life of only six months after opening (Clasen and Edmondson, 2006) compared to the shelf-life of NaDCC tablets of several years. Decreasing concentrations in liquid chlorination products reduce the effectiveness of the method.</p>



## 2.2 Household level

Water can also be chlorinated by the individual customer at the household level. Chlorine tablets (e.g. Aquatabs; Natriumdichloroisocyanurate (NaDCC) tablets) or liquid chlorine (e.g. WaterGuard; NaOCl solution) are added to a 10 or 20 litre container. Whereas dosing consistency is high (especially for the tablets), consistent application by the users has been found to be difficult (McLaughlin et al., 2009, Levy et al., 2014). Furthermore, liquid chlorine evaporates and decays quickly if exposed to heat. Even in a tightly closed opaque bottle, stabilised NaOCl has a recommended shelf-life of only six months after opening (Clasen and Edmondson, 2006), while NaDCC tablets have a shelf-life of several years. Decreasing concentrations in liquid chlorination products reduce the effectiveness of the method.

# 3 Safe storage

In addition to chlorination, keeping the storage vessels hygienic is an important strategy to reduce the risk of recontamination. Whenever water is stored in an unhygienic environment, the risk of recontamination arises. This section discusses methods to make storage safer at the system level and at the household level.

## 3.1 System level

Treated water is stored in a clean water tank until it is distributed to the users. Simple, but effective measures to limit recontamination risks during storage in the clean water tank are:

- Properly close the clean water tank with a lid at all times. The lid should be tight (see Figure 51) and ideally threaded to keep small animals, debris or dust from entering the tank.
- Regularly clean and disinfect the clean water storage tank (see Part II, section 4.3.1)
- Limit the storage time. With a high turnover (regular water sales), this can be achieved.



Figure 51: Tightly closed tank lid

## 3.2 Household level

In a kiosk set-up, the users usually collect the water in a container to carry the water to their home and store it until consumption. These containers are often not hygienic and thereby can trigger recontamination or re-growth in the treated water. In containers used at household level for water transport and storage, measures to reduce recontamination include:

- Use of safe storage containers with lids
- Regular cleaning and disinfecting of the storage container
- Limit the storage time at the household level

An assessment that looked at water quality in jerrycans that were not cleaned nor disinfected revealed that 86 % of the containers contained E.coli after 24 h of storage in the jerrycan, although the containers were originally filled with clean water. Therefore, different strategies were evaluated to reduce recontamination risks during transport and storage and guarantee safe water until the point of consumption 24 h after collecting the water at the tap (Gärtner et al., 2021). The study showed that the systematic cleaning and disinfection of the jerrycans in combination with chlorinating the drinking water at the kiosk are effective strategies to reduce the recontamination risk in water containers.

### Cleaning and disinfecting of jerrycans

The cleaning of conventional jerrycans with a brush or a cloth was not possible due to the small opening of the whole in the container. Therefore, sand was used for the cleaning procedure. A handful of sand and chlorinated water was introduced into a jerrycan, then it was shaken for about 1 min. Afterwards, the sand was rinsed out with about 10L of chlorinated water. Then, the jerrycans were filled with 5L of water mixed with liquid soap, shaken, and rinsed again with chlorinated water. The cleaning procedure using sand is not optimal, because the use of sand scratches the wall of the containers. These scratches build room for the growth of biofilm which can again harbour pathogens and can make future cleaning increasingly more difficult.

To guarantee that the users consume safe water, it is essential to think about strategies that keep the water safe during transport to the household and during storage. Strategies, such as chlorinating the water to provide residual disinfection or the use of safe storage containers, can protect the water and reduce the risk for recontamination. Ideally, different protective measures are being combined, i.e. chlorinating the water, preferably at the system level, and cleaning and disinfecting the jerrycans prior to filling them with treated water.



### Safe storage containers

A storage container should have an adequate size (10 - 20L) and be portable, cheap and locally available. A safe storage container should have the following features (see Figure 52):

- Opaque shape
- Can be entirely closed with a threaded lid
- Adequate type and size of opening (Small enough to discourage scooping, but large enough to be able to clean the container properly, e.g. about 10 cm).
- Optional: Tap or spigot at the container or use a dispenser with a tap. This has the advantage of making it easy to get the water out of the container and recontamination risks are reduced. However, a spigot is usually the most fragile part, and spigots should be easily replaceable and accessible to the users.



Figure 52: Safe storage container

# Part V: Sustainable Management



Numerous reports of water supply systems that failed after some years of operation or never were functional are available. Communities were unable to cope with the management of their schemes, poor maintenance, lack of financing, breakdowns, poor water quality, lack of support and, ultimately, an unreliable and disrupted water supply to the people. An assessment in several countries found non-functionality of all systems at any time to be between 30-40% (Lockwood and Smits, 2011). Foster et al. (2020) reported that approximately one in four hand pumps were non-functional in sub-Saharan Africa at any point in time. However, water treatment systems can remain operational with a sustainable management system. A sustainable management system is characterized by integrated decision-making, democratic values, knowledge, awareness, information, collaboration, equity, justice, long-term solutions, compliance of regulations, good leadership, and finally consideration of future generations (Pal, 2017).

Even though it is indispensable to have a suitable, locally adapted technology to treat drinking water it is also indispensable to establish a locally adapted and suitable management and service framework. The previous parts of this guide focused on technological aspects of GDM water treatment systems. This part focuses on the non-technological aspects that are relevant to secure the sustainable operation of a water treatment system. In the first section, methods are described to monitor the water quality and ensure that the water produced is safe to drink. Then, the importance of business models are highlighted, as financial sustainability is key for the long-term operation of a water supply system. Additionally, different management models are described outlining how different stakeholders can take different roles and responsibilities. Finally, a holistic planning approach is introduced via the concept of the “enabling environment”.



Figure 53: Non-functional water tap (© Jason Allardyce)

# 1 Water quality monitoring

Water supply in most areas of the developing world is challenged by microbiological pollution. Drinking water is one of several possible transmission routes for infectious diseases. In addition to drinking water, diseases causing pathogens can be transmitted via other routes such as person-to-person transmission and food-borne transmission, which can be interrupted by good sanitation and hygiene practices. Since water treatment facilities may not always operate reliably and water may get contaminated during transport and storage, it is important to monitor the quality of the water distributed to know if the water supplied is safe for human consumption or not. Consumers may think that the water is safe to drink when they see it is clear and has a good taste and odour. However, the human eye, taste and smell cannot detect microbiological contamination.

A community scale drinking water treatment provides water for a large number of people. If the water provided by the facility is not safe for consumption, it creates a public health risk for a large number of consumers. Therefore, it is important to conduct quality control measures at the water treatment system and to regularly analyse the water quality provided to the customers. Immediate actions have to be taken if the results of water quality analysis are not satisfying.

This section introduces the parameters “Colony forming unit (CFU) of *E. coli*” and “log reduction value (LRV)” to monitor the water quality and provides an explanation on how to analyse them and how to interpret the results.

## 1.1 Faecal contamination (CFU of *E. coli*)

Unfortunately, it is not possible to measure all existing pathogens in drinking water. There are simply too many different disease-causing microbes and complicated laboratory analysis may be required to detect some of them. Therefore, indicator organisms are monitored. An indicator does not measure a specific pathogen directly, but gives a good approximation of the likelihood of pathogens being present in the water. Most water-borne diseases are caused by faecal contamination. Therefore, a useful indicator to monitor faecal contamination has the following properties: it is universally present in faeces of humans and animals in large numbers, it does not multiply in natural waters, it persists in water in a similar manner to faecal pathogens, it is present in higher numbers than faecal pathogens, it responds to treatment processes in a similar fashion to faecal pathogens and it can be readily detected by simple, inexpensive culture methods (WHO, 2017a). *Escherichia coli* fulfils many of these criteria and, therefore, is a widely used indicator of faecal contamination. It is present in very high numbers in human and animal faeces and is rarely found in the absence of faecal pollution. Water temperatures and nutrient conditions in drinking-water distribution systems are highly unlikely to support the growth of these organisms (WHO, 2017a). It is also relatively easy to detect by membrane filtration, later described in this section. In most circumstances, populations of thermo tolerant coliforms are composed predominantly of *E. coli*. As a result, thermotolerant coliforms are regarded as a less reliable, but acceptable, indicator of faecal pollution (WHO, 2017a). Total coliform bacteria are not acceptable as an indicator of the sanitary quality of water supplies, as they are abundantly present in natural waters and are of no sanitary health significance (WHO, 2017a). Thermotolerant coliforms is a subgroup of total coliform bacteria, *E. coli* a subgroup of thermotolerant coliforms (see Figure 54).

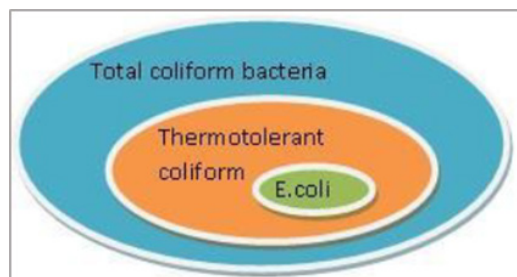

Figure 54: Grouping of faecal indicator bacteria(Kanangire, 2013)

### 1.1.1 Sampling of water to be tested

Before analysing the water, a representative water sample of 100ml has to be collected.

When taking a sample, it is important to consider the following:

- Use a sterile sampling bag (e.g. Whirl Pak® from Nasco) or sterile bottle and collect a bit more than 100ml of water
- Before taking the sample, disinfect the water tap by flaming or swiping it with 80 % Ethanol.
- Then, let the water first run for 5 - 10 seconds
- Keep the sample dark and cool (on ice) until analysis (max 6h)

A detailed procedure for water sampling can be found in the Appendix E.

### 1.1.2 Analysis using membrane filtration

To conduct water quality analysis using membrane filtration, the following materials are required:

- 100ml water sample
- individually packed sterile membrane filters (diameter 47mm, pore size 45µm)
- agar plates (compact dry plates or self-produced)
- a membrane filtration funnel with ball pump to create a vacuum
- Methanol for disinfection, tweezers
- a lighter
- incubator or body belt

In this guide we reference the manufacturers that we rely on, knowing that many other high-quality manufacturers exist in the market with alternative products.

After filtration of the water sample through the sterile membrane filter (Figure 56), the filter paper is placed on an agar plate and cultivated for 24 hours in an incubator at 35 - 37°C. The bacteria retained on the filter paper start to grow on the agar plate. After 24h, colony forming units (CFU) can be counted (Figure 55). A CFU is a bacteria population that grew during the incubation period, large enough to be detected by the human eye. A good video that describes this method produced by Loughborough University is available on YouTube (<https://www.youtube.com/watch?v=B1AVxzccS5Q>). If no incubator is available, body incubation belts (see Figure 57) or money belts can serve as an alternative. When a body belt is used, the agar plates are placed into the belt, which is wrapped around the human body during the incubation period. The agar plates can either be self-produced with testing kits (available e.g. from **DelAgua** or **Wagtech Projects Ltd.**) or purchased (e.g. EC compact dry plates (CDP), **Hyserve**, see Figure 55). It is labour-intensive to self-produce agar plates and a laboratory setting is required, but self-production is more economical than CDPs. In contrast, CDPs are ready for use and, therefore, easier to handle. The cost, however, are higher (~1.5USD per plate) than if agar plates are self-produced. CDPs have a shelf-life of 18 months after manufacturing.



Figure 55: EC dry plate. Dots indicate CFUs. Blue = E. coli, purple = total coliforms



Figure 56: Membrane filtration funnel, **DelAgua**



Figure 57: Body belt of **ENPHO**

If no funnel is available for the membrane filtration, a rough analysis can be done by pouring 1 ml of the water directly on an EC dry plate. A sterile syringe or pipette is used to sample 1ml of water and pour it onto the EC dry plate. The plate is incubated for 24 h at 35 - 37 °C and afterwards the colonies are counted. The result is presented in CFU/ml as opposed to the membrane filtration method, where the result is presented in CFU/100ml. If the result is wanted in CFU/100ml, it is necessary to multiply the number of colonies counted by 100. Due to the lower detection limit within 1 ml sample, only the “high risk” and “very high risk” categories, according to WHO, can be detected (compare with Table 13). Lower risk categories cannot be detected using this method.

For detailed manuals about the methods presented for water quality analysis, refer to the providers in Table 12. Their manuals can be downloaded via the links in the table for free.



It is recommended to test for faecal contamination at least once per month using the membrane filtration method. If possible, more frequent testing is encouraged. If faecal contamination is detected in the treated water, immediate action must be taken.

Table 12: Weblinks of manuals for microbiological water quality analysis as examples

Item	Product name, <i>Company</i> and weblinks
Sampling bags	Whirl Pak ©, <b>Nasco</b> Manual: <a href="https://www.whirl-pak.com/whirl-pak-bags-general-information">https://www.whirl-pak.com/whirl-pak-bags-general-information</a> or Appendix E Videos: <a href="https://www.whirl-pak.com/video-resources">https://www.whirl-pak.com/video-resources</a> Order from: Guth South Africa <a href="https://guth.co.za/sample-handling/?ic_source=distributor&amp;ic_creative=LP&amp;ic_id=guth-0720">https://guth.co.za/sample-handling/?ic_source=distributor&amp;ic_creative=LP&amp;ic_id=guth-0720</a>
Body incubation belt	Body incubation belt, <b>ENPHO</b> <a href="https://enpho.org/products-2/body-belt-incubator/">https://enpho.org/products-2/body-belt-incubator/</a>
Water testing kit including membrane filtration funnel	Portable Water Testing Kit, <b>DelAgua</b> Manual: <a href="https://www.delagua.org/wp-content/uploads/2021/04/DelAgua-Manual-Revised-2020-V1.pdf">https://www.delagua.org/wp-content/uploads/2021/04/DelAgua-Manual-Revised-2020-V1.pdf</a> Videos: <a href="https://www.delagua.org/learning#library-anchor">https://www.delagua.org/learning#library-anchor</a> Order from: <a href="https://www.delagua.org/products/distributors">https://www.delagua.org/products/distributors</a>
Water testing kit including membrane filtration funnel	Wagtech Potalab®, <b>Palintest</b> Manual: <a href="https://www.manualslib.com/manual/1636832/Palintest-Wagtech-PotalabPlus-M.html">https://www.manualslib.com/manual/1636832/Palintest-Wagtech-PotalabPlus-M.html</a> Video: <a href="https://www.youtube.com/watch?v=B1AVxzcS5Q">https://www.youtube.com/watch?v=B1AVxzcS5Q</a> Order from: <a href="https://www.palintest.com/products/potalab/">https://www.palintest.com/products/potalab/</a>
EC dry plates	CompactDry™ EC, <b>Nissui Pharmaceuticals</b> Manual: <a href="http://www.fcbiotech.com.tw/wp-content/uploads/2017/10/CompactDry_EC_E.pdf">http://www.fcbiotech.com.tw/wp-content/uploads/2017/10/CompactDry_EC_E.pdf</a> ; <a href="https://food.r-biopharm.com/products/compact-dry-ec/">https://food.r-biopharm.com/products/compact-dry-ec/</a> Order from: <a href="https://hyserve.com/produkt.php?lang=en&amp;gr=1&amp;pr=13">https://hyserve.com/produkt.php?lang=en&amp;gr=1&amp;pr=13</a>

### 1.1.3 Interpretation of water quality analysis results

To comply with the Guidelines for drinking water quality of WHO, drinking water should not contain any E.coli (< 1 CFU/100ml). In accordance with contamination levels detected, WHO defined five risk categories (see Table 13): from conformity with WHO (0CFU/100ml) to very high risk (> 1000CFU/100ml) (WHO, 1997). The risk category standards define the urgency of an intervention. If the water sample meets the WHO standards, no action is required. For the intermediate risk category, the situation should be closely monitored. If the analysis repeatedly results in the intermediate category, actions to improve the water quality are required. If the risk is high, immediate action must be taken to improve the water quality. If the analysis detects a very high

risk, it is recommended to immediately stop the distribution of water and take actions to improve the water quality in the GDM treatment system by: a general check-up of the membranes (see Part II, section 4.3.2), disinfection of the clean water tank (see Part II, section 4.3.1), investigation of the clean water tank and connections to the water tap to find possible sources of recontamination and doing a membrane integrity test to assess if the membrane is damaged (see next section 1.2).

Table 13: Classification of *E. coli* in risk categories (WHO, 1997)

E. coli [CFU/100ml]	Classification
< 1	In conformity with WHO guidelines
1-10	Low risk
11-100	Intermediate risk
101-1'000	High risk
> 1'000	Very high risk

## 1.2 Integrity of the membrane (LRV)

A membrane integrity test is used to assess the effectiveness of the membrane to remove bacteria. A defined concentration of a non-pathogenic bacteria, such as probiotic *Enterococcus* bacteria, is passed through the membrane and the concentration of bacteria before and after the treatment is measured. It is expected that the number of bacteria before the treatment would be high and after the treatment low. In this case, the membranes substantially reduce the number of bacteria. The bacterial removal efficiency of a treatment process is quantified in "Log reduction value" (LRV). A LRV is determined by taking the logarithm of the ratio of contamination before and after the treatment (see Equation 1).

A LRV of 1 is equivalent to 90 % reduction of the analysed organism, a LRV of 2 is equivalent to 99 % reduction, a LRV of 3 to 99.9 %. Ideally, the LRV of the UF membrane is >4, meaning that 99.99 % of bacteria are removed. In other words, if we take a 1 ml sample of the raw water and a 100 ml sample of the permeate water and:

$$\begin{aligned} \text{LRV} &= \log_{10} \left( \frac{\text{CFU}/100\text{ml}_{\text{raw water}}}{\text{CFU}/100\text{ml}_{\text{permeate water}}} \right) \\ &= \log_{10} (\text{CFU}/100\text{ml}_{\text{raw water}}) - \log_{10} (\text{CFU}/100\text{ml}_{\text{permeate water}}) \end{aligned}$$

Equation 1: Log Reduction Value

- more than 100 CFU/ml (= more than 10'000 CFU/100ml) in the raw water and a
- maximum of 1 CFU/100ml in the permeate water are detected
- the  $\text{LRV} = \log_{10}(\frac{>10'000}{1}) > 4$

The integrity of the whole water treatment process can be analysed by taking the clean water sample at the distribution tap. The integrity of the membranes can be checked by taking the clean water sample after the membrane modules (from the membrane permeate pipe). This guide presents the procedure to assess the membrane integrity and it is recommended to use probiotic bacteria (not harmful to humans) as an indicator, e.g. *Enterococcus faecium*. *Enterococcus* bacteria can be found in pharmacies as capsules to support the intestinal flora. ETC dry plates need to be used to conduct the membrane integrity test with probiotic *Enterococcus* organisms.

Scan the QR code to watch the video "Recontamination risks" of our series or go to <https://youtu.be/CZX2d4tQVHg>





### 1.2.1 Procedure for a direct membrane integrity test (complete manual in Appendix B)

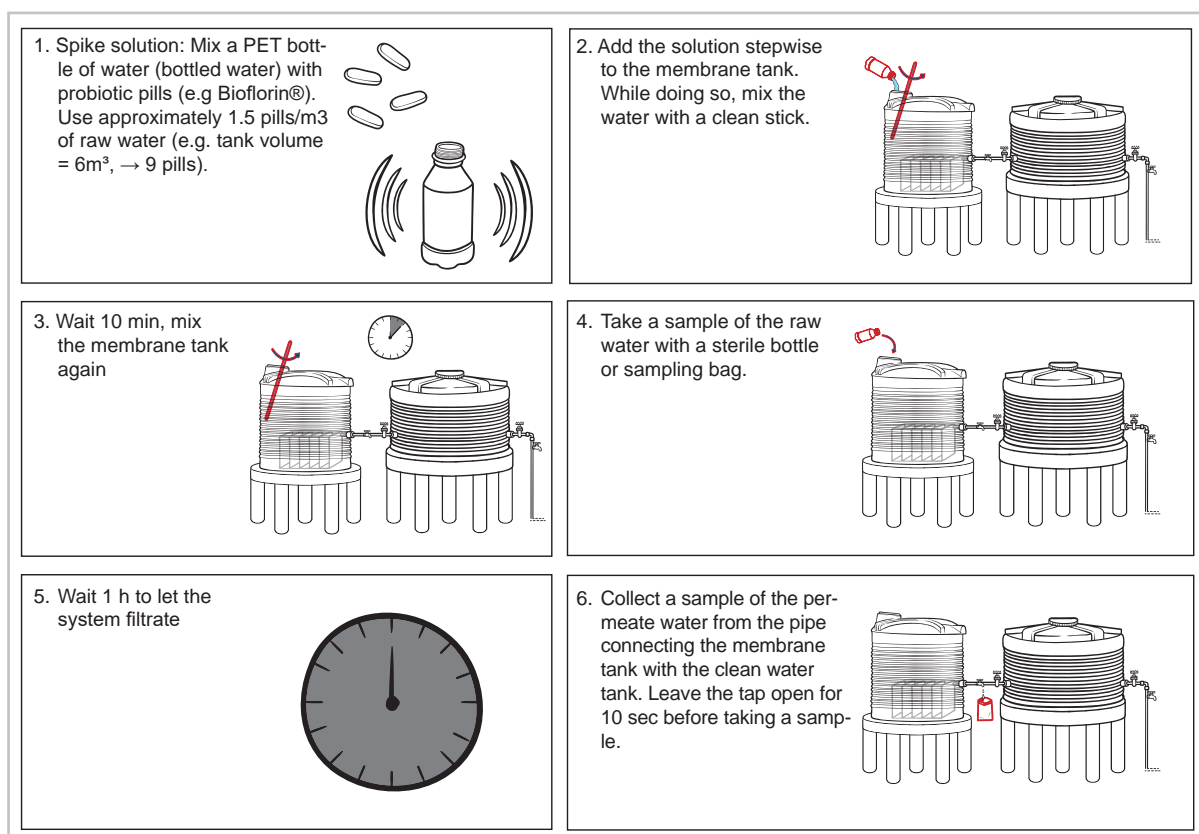

### 1.2.2 Interpretation of a Membrane integrity test

Table 14 helps to interpret the LRV of the membrane integrity test. If the LRV is larger than 4, no action must be taken and the performance of the membranes is as expected. If the LRV is below 4, the membranes perform below expectations and doing a general system check should be taken into consideration (see Part II, section 4.3.2). Table 14 what *Enterococci* concentrations can be expected at the tap in dependence of the LRV values achieved. It is important to mention, that the LRV is a ratio between the concentration of CFU of the analysed organism in the raw water (before the membrane) and in treated water (after the membrane). If the concentration in the raw water is smaller than 10'000CFU/100ml (this could happen if not sufficient tablets with probiotic bacteria were added to the raw water tank), the LRV is always smaller than 4! On the other hand, if the concentration in the raw water is too high, the LRV might be larger than 4 but the water quality after treatment still not safe for consumption according to Table 13. Please note that the proper functioning of the membranes can only be assessed if the concentration of probiotic bacteria in the raw water tank is 10'000 - 20'000 CFU/100ml (= 100-200 CFU/1ml). Therefore, the values of expected *Enterococci* concentrations at the tap in Table 14 are valid for a raw water concentration of 10'000 - 20'000 CFU *Enterococci*/100 ml. If the test results indicate that the *Enterococci* concentration in the raw water was out of this range, repeat the integrity test and adjust the number of *Enterococci* pills added to the raw water tank.

Table 14: Interpretation of LRV results for a raw water concentration of 10'000 - 20'000 CFU *Enterococci*/100 ml

LRV	Interpretation	Expected <i>Enterococci</i> concentration at the tap
> 4	Very high pathogen reduction	0 - 1 CFU/100ml
3 - 4	High pathogen reduction	2 - 10 CFU/100ml
2 - 3	Intermediate pathogen reduction	11 - 100 CFU/100 ml
1 - 2	Low pathogen reduction	101 - 1000 CFU/100ml
< 1	Very low to no pathogen reduction	> 1'000 CFU/100ml

## 2 Business model

Generating an income is necessary to cover the costs of running and maintaining the water treatment system and achieving a sustainable operation. A proper planning of the enterprise should be conducted on the basis of a well-conceived business model to achieve financial sustainability. "A business model describes the rationale of how an organization creates, delivers and captures value" (Osterwalder and Pigneur, 2010). Generating enough revenues is important to pay for recurring expenses for operation and maintenance to assure a high service level and keep the water treatment system operational.

This section describes the business model canvas, introduces the "four A's" for innovations at the bottom of the pyramid, and presents four business models for emerging markets that look at the poor as customers rather than beneficiaries.

The Business Model Canvas is described in detail in the book "Business model generation: a handbook for visionaries, game changers, and challengers" by Osterwalder and Pigneur (2010).



### 2.1 Business Model Canvas (Osterwalder and Pigneur, 2010)

The business model canvas is a concept that helps to describe and think through the business model of a GDM project. This concept that has been applied by many large organisations, such as IBM, Ericsson, Deloitte and many more. The business model is segregated into nine building blocks that form the basis of a proper business plan (illustrated in Figure 58). The **Customer Segments** block defines the different groups of people or organisations an enterprise aims to reach and serve. Without customers, no business can survive long. The **Value Proposition** block describes the bundle of products and services that create value for the customers. It solves a customer problem or satisfies a customer need. The **Channels** block describes how a company interacts with and reaches its customers to deliver a value. Channels include several functions, such as: Raising awareness, helping to evaluate a value proposition, allowing for the purchase of products and services, delivering a value proposition and providing customer support. The **Customer Relationships** block describes the types of relationships a company establishes with specific customers. It could be personal assistance, self-service, automated services, etc. The **Revenue Streams** block represents the cash a company generates from each **Customer Segment** (costs must be subtracted from revenues to create earnings). The key question here is, for what value is a customer truly willing to pay? One time payments, as well as recurring payments, are possible. The **Key Resources** block describes the most important assets the enterprise requires to make its business model work. They can be physical (infrastructure or vehicles), human (know-how or expertise), intellectual (copyrights, patents, customer database, etc.), or financial (guarantees). They can be owned, leased or acquired from key partners. The **Key Activities** block describes the most important things a company needs to do to make its business model work. They can be categorised in production (dominating for manufacturers), problem solving (dominating for consultants) and platform/network (dominating for service providers). The **Key Partnerships** block describes the network of suppliers and partners that make the business model work. There are four different types of partnerships: strategic alliances with non-competitors, strategic partnerships with competitors, joint ventures to develop new businesses, and supplier relationships to assure supplies. The **Cost Structure** block describes all costs incurred to operate a business model. Fixed costs are independent of the volume of goods produced (salaries and manufacturing facilities). Variable costs vary proportionally with the volume of goods produced (e.g. raw materials).

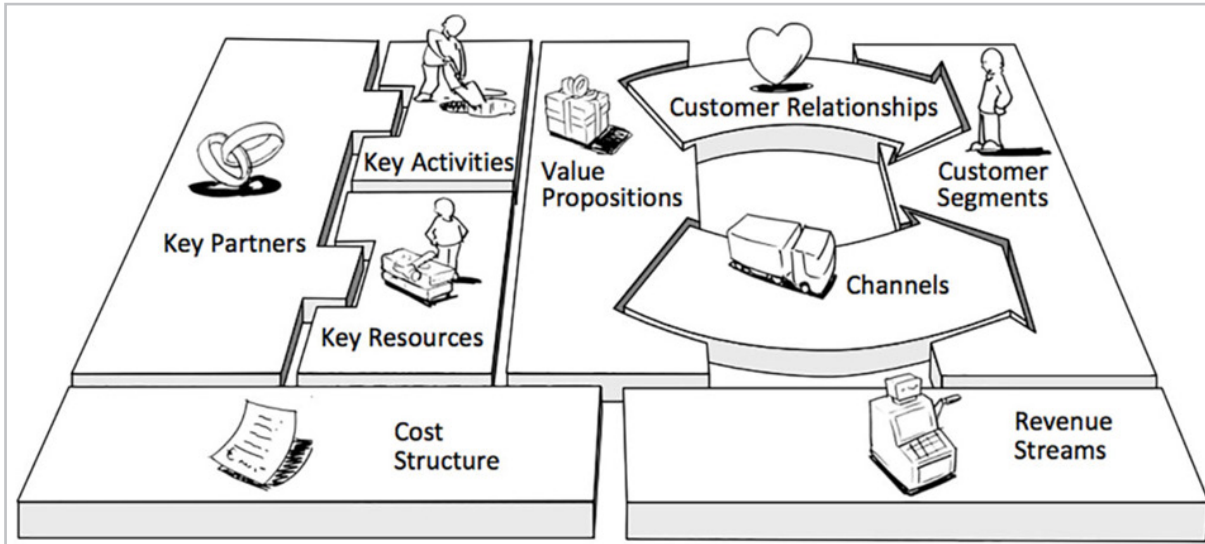

Figure 58: The 9 building blocks of a business model (adapted from Osterwalder and Pigneur (2010))

The nine building blocks of a business model form the basis of a tool that is called the Business Model Canvas (see Figure 59). The best way to understand this tool is to print it out and elaborate how the different blocks are constituted in your own business model in a participatory process.











<p><b>Key Partners</b> </p> <ul style="list-style-type: none"> <li>• Who are our key partners?</li> <li>• Who are our key suppliers?</li> <li>• Which key resources are we acquiring from partners?</li> <li>• Which key activities do partners perform?</li> </ul>	<p><b>Key Activities</b> </p> <ul style="list-style-type: none"> <li>• What Key Activities do our Value Propositions require?</li> <li>• Our Distribution Channels?</li> <li>• Customer Relationships?</li> <li>• Revenue streams?</li> </ul> <p><b>Key Resources</b> </p> <ul style="list-style-type: none"> <li>• What Key Resources do our Value Propositions require?</li> <li>• Our Distribution Channels? Customer Relationships?</li> <li>• Revenue Streams?</li> </ul>	<p><b>Value propositions</b> </p> <ul style="list-style-type: none"> <li>• What value do we deliver to the customer?</li> <li>• Which one of our customer's problems are we helping to solve?</li> <li>• What bundles of products and services are we offering to each Customer Segment?</li> <li>• Which customer needs are we satisfying?</li> </ul>	<p><b>Customer Relationships</b> </p> <ul style="list-style-type: none"> <li>• What type of relationship does each of our Customer Segments expect us to establish and maintain with them?</li> <li>• Which ones have we established?</li> </ul> <p><b>Channels</b> </p> <ul style="list-style-type: none"> <li>• Through which Channels do our Customer Segments want to be reached?</li> <li>• How are we reaching them now?</li> <li>• How are our Channels integrated?</li> </ul>	<p><b>Customer Segments</b> </p> <ul style="list-style-type: none"> <li>• For whom are we creating value?</li> <li>• Who are our most important customers?</li> </ul>
<p><b>Cost Structure</b> </p> <ul style="list-style-type: none"> <li>• What are the most important costs inherent in our business model?</li> <li>• Which Key Resources are most expensive?</li> <li>• Which Key Activities are most expensive?</li> </ul>		<p><b>Revenue Streams</b> </p> <ul style="list-style-type: none"> <li>• For what value are our customers really willing to pay?</li> <li>• For what do they currently pay?</li> <li>• How are they currently paying?</li> <li>• How would they prefer to pay?</li> <li>• How much does each Revenue Stream contribute to overall revenues?</li> </ul>		

Figure 59: Business model canvas (adapted from Osterwalder and Pigneur, 2010)





Scan the QR code to watch the video "Business Model Canvas" of our series or go to <https://youtu.be/uU9SXsva6Kk>

## 2.2 The four A's - Anderson and Markides (2007)

At the bottom of the pyramid, the success of new products and services is based on four factors: Affordability, Acceptability, Availability and Awareness (Anderson and Markides, 2007). In the context of a water kiosk:

- **Affordability** refers to the water price. One way of measuring affordability is the proportion of the household budget spent on water services. Even though there is no international consensus, the United Nations Development Programme, the World Bank, the Organization for Economic Cooperation and Development, the European Commission and the African Development Bank have all defined affordability thresholds for water between 3 - 5% (WHO, 2021).
- **Acceptability** refers to the willingness to purchase, distribute or sell the water. Cultural issues and specific needs of the customers need to be considered.
- **Availability** addresses the possibility of the consumer to access the water. Especially in sparsely populated areas, it is challenging to find a kiosk location close to many potential customers. Availability also refers to factors that could limit the consumers regular access to water, such as the availability of water at the water treatment station, the availability of spare parts and consumables to operate the business, limited opening hours or droughts.
- **Awareness** refers to the knowledge of the consumers about the benefits of consuming safe water. Often, this knowledge is limited and awareness raising campaigns are necessary to convince consumers to pay for safe water.

## 2.3 Business models for emerging markets

In their book "Emerging Markets, Emerging Models", Karamchandani et al. (2009) emphasised that the most common mistake among market-based solutions is to confuse what low-income customers ostensibly need with what they actually want. They identify four business models that focus on serving the poor as customers:

- **Pay-per-use:** Customers pay for each use instead of owning an asset. Translated to the GDM technology, this means that consumers buy water from a centralised water kiosk rather than owning a GDM household water filter. This concept prefers pay per jerrycan rates as opposed to monthly subscriptions.
- **No frills service:** Economising at every stage, i.e. bringing down the unit cost. It is reached by a high throughput and "bare bone" services without extras. For a water kiosk this means maximising the number of customers per kiosk, having several kiosks in an area that are served by the same service provider, and selling "bare" water (e.g. without packaging).
- **Paraskilling:** This principle is the same as no frills service, but includes simplifying key processes so that lower-skilled workers could perform them, instead of expensive high-skilled experts. Another benefit of involving the rural community in the business model is that income opportunities are created and links to potential customers are efficiently made (Gradl and Knobloch, 2010). In the water kiosks, skilled personnel is mainly needed for maintenance work. Following the paraskilling principle, it is important to simplify and standardise this work as much as possible, so that local mechanics or community members can carry it out.
- **Shared channels:** Use existing distribution platforms originally created for other purposes. Some examples are buses, which in addition to passengers, also carry goods and telecommunication networks that increasingly offer additional services, such as micro-financing. In the context of the water kiosk, a distribution system for spare parts that is based on an existing platform or a distribution system for jerrycans filled with treated water could be envisioned. In addition to channels, Gradl and Knobloch (2010) suggest to also share capabilities and resources with other organisations, e.g. a car mechanic with technical skills could be hired to service the pump of a GDM kiosk.

## 2.4 The business model in the example of Uganda

Above, the four A's of Anderson and Markides (2007) were presented. They can be used to characterize the potential for successful entrepreneurship at the bottom of the economic pyramid. In our case example of the GDM water kiosks, the four A's were addressed as follows: water was sold at an **affordable** price with "affordable" being defined as "3 - 5 % of the household income" by many international organisations. With an average rural income of 1 USD/day (= 30USD/month), three to five per cent of the overall income corresponds to an affordable water cost of about 0.9 - 1.50 USD/month. At the GDM water kiosks, water is sold at 50 - 100 UGX per jerrycan (= 0.013 - 0.026USD). With this water price, an average household would be able to buy about two to four jerrycans per day without exceeding the threshold of 5 % household income. The volume of water purchased therewith would be sufficient to cover a household's needs of drinking water, personal hygiene and food preparation. Additional water required for other activities, such as cleaning or washing clothes could be covered with water of lower quality. At one site in our case study example, the water was sold through monthly subscriptions at 0.92USD/month (~3 % of household income) that offered the customers the option to fetch up to three jerrycans per day. A committee of community members and teachers from the primary schools where the kiosks are located run the kiosks. From the beginning, the community was involved in planning and decision making, to have the highest possible **acceptability** for the project.

Before the GDM kiosk, safe drinking water was not **available** in the region. Only salty groundwater and contaminated surface water from Lake Victoria were used as water sources. At some of the sites, people had to walk up to 2 km to collect water from Lake Victoria. The water kiosks now provide them with water at a closer vicinity and with a better quality. Opening hours of the kiosks were adapted to the daily schedule of the users. With the introduction of water ATMs, the water now is accessible 24 hours a day.

A variety of promotion and community education activities were implemented to create **awareness** for the importance of safe drinking water. At the schools, WASH was introduced into the curriculum and hygiene training workshops were conducted with the community. Only if community members are convinced of the benefits of safe water are they also willing to pay for it. Raising awareness for safe water is not an easy task and depends upon continuously implemented behaviour change activities over an extended period of time.

Figure 60 presents the business model canvas that was developed for the Ugandan GDM kiosks.









<p><b>Key Partners</b> </p> <ul style="list-style-type: none"> <li>Local technicians</li> <li>University of Applied Science Busia</li> <li>Local NGOs</li> <li>Local Government</li> <li>Suppliers for materials and spare parts</li> </ul>	<p><b>Key Activities</b> </p> <p><u>Current activities</u></p> <ul style="list-style-type: none"> <li>Sale of safe drinking water</li> <li>Sale of hygiene products</li> </ul> <p><u>Potential future activities</u></p> <ul style="list-style-type: none"> <li>Home delivery of water</li> <li>Charging of phones</li> </ul> <p><b>Key Resources</b> </p> <ul style="list-style-type: none"> <li>Infrastructure &amp; assets</li> <li>Community ownership (contribution of labour &amp; resources)</li> <li>Local know-how</li> <li>Local workforce (Management &amp; operation)</li> </ul>	<p><b>Value propositions</b> </p> <ul style="list-style-type: none"> <li><b>Provide access to safe drinking water at a fair price</b></li> </ul>	<p><b>Customer Relationships</b> </p> <ul style="list-style-type: none"> <li>Nearby, affordable, reliable provision of drinking water</li> <li>Customer-friendly service</li> <li>Accountability and transparency</li> </ul> <p><b>Channels</b> </p> <ul style="list-style-type: none"> <li>Household promotion of service</li> <li>Billboards</li> <li>Community meetings</li> <li>Education in schools</li> <li>Direct customer contact</li> </ul>	<p><b>Customer Segments</b> </p> <p><u>Get water for free:</u></p> <ul style="list-style-type: none"> <li>Schools</li> <li>Poorest families</li> </ul> <p><u>Pay for water:</u></p> <ul style="list-style-type: none"> <li>Households in the catchment area of the kiosk</li> </ul>
<p><b>Cost Structure</b> </p> <p><u>Operational expenses covered by revenues</u></p> <ul style="list-style-type: none"> <li>Salaries (kiosk operator, local technicians), repairs</li> </ul> <p><u>Expenses covered by donations</u></p> <ul style="list-style-type: none"> <li>Infrastructure, training &amp; capacity development, initial promotion of service</li> </ul>		<p><b>Revenue Streams</b> </p> <p><u>Pay per use:</u></p> <ul style="list-style-type: none"> <li>100 UGX per jerrycan, cashless pre-paid (water ATM)</li> </ul> <p><u>Monthly subscription:</u></p> <ul style="list-style-type: none"> <li>3'500 UGX per month for 3 jerrycans per day</li> </ul>		

Figure 60: Business model (Osterwalder and Pigneur (2010) for the Ugandan GDM kiosks

# 3 Management models

While planning a water treatment system, you have to decide how the drinking water system will be managed and operated. Who owns the treatment facility? Who is responsible for daily operation and minor maintenance work? Who is responsible for repairs and major maintenance work? How will decisions regarding the O&M of the water system be made? How are water fees collected? These are some of the important questions to ask while thinking about the operating model of the water treatment system. Usually, different stakeholders play a role in the operation and maintenance of a water system. The stakeholders can be categorised as “local community”, “public authorities” and “external organisations”. In the following, three management models are described. In every model, one of the stakeholder categories mentioned has the main responsibility for operating and maintaining the water system. A combination and mix of the different models is often found in practice.

The "2019 RWSN directory of rural water supply services, tariffs, management models and lifecycle costs" (RWSN, 2019) provides an extensive overview of different management and business models of water supply systems.



## 3.1 Management by local community

This is a community-centred approach. The treatment facility is owned, operated and managed by the local community. An elected Water User Committee (WUC) takes the lead.

Table 15: Advantages and Limitations of the community-centred approach

<ul style="list-style-type: none"> <li>+ Proximity to users</li> <li>+ Knowledge is locally available</li> <li>+ Local involvement and ownership of the water treatment system</li> <li>+ Support from volunteers possible</li> <li>+ Community can provide labour and financial support if necessary</li> </ul>	<ul style="list-style-type: none"> <li>- Steering can be difficult because diverse interests are represented in the management body</li> <li>- Susceptible to conflicts</li> <li>- High danger for mismanagement or abuse or resources generated by the sale of water</li> <li>- Motivation of volunteers is limited if they have no direct benefit</li> <li>- Limited resources in case of maintenance expenses</li> <li>- Limited technical skills</li> <li>- Limited management skills</li> <li>- Need for external investment to set-up the facility</li> </ul>
--	---

## 3.2 Management by government

In this case, the public authorities directly manage the facility. This could be a municipality or district government, or for a larger infrastructure, regional or even national departments. Governments usually give contracts to community members for operation and small repairs.

Table 16: Advantages and Limitations of the management by the public authorities

<ul style="list-style-type: none"> <li>+ Government institutions are permanent structures</li> <li>+ Technical know-how to service and maintain facilities is usually available at national level</li> <li>+ Installation and operation of the facility can be subsidised by tax money</li> </ul>	<ul style="list-style-type: none"> <li>- Difficult to retain good professionals in the public departments</li> <li>- Skills at decentralised level are often limited</li> <li>- Limited budgets and incentives to provide good service</li> <li>- High fluctuation of trained staff</li> <li>- Distance of Government offices to the treatment facility</li> </ul>
---	--

### 3.3 Management by external organisation

An external NGO, social enterprise or private company takes the lead for the management of the facility. Often, the operation and minor repairs are done by contracted community members and they are in contact with the organisation running and owning the facility. Trained technicians are in charge of larger maintenance work and assist the local operators. Major repairs are paid by the external organisation.

Table 17: Advantages and Limitations of the management by an external organisation

<ul style="list-style-type: none"> <li>+ Resources and skilled technicians available</li> <li>+ Usually lean and well organised management in a private company</li> </ul>	<ul style="list-style-type: none"> <li>- Resources and capacity not local</li> <li>- No local income generation</li> <li>- Limited sustainability: once the managing organisation leaves, the knowledge and resources also leave</li> <li>- The sector is not very attractive for private enterprises and profit margins are very low</li> </ul>
--	--

### 3.4 Management in the example of Uganda

For the water kiosks in Uganda, a community centred management model was implemented. The GDM kiosks are owned by the communities. For every kiosk, a committee was elected to manage the water kiosk and organise daily operation and the water kiosk management committee received support from a local NGO. The different stakeholders involved and their responsibilities are described in Table 18.

Table 18: Responsibilities of different stakeholders of GDM kiosks in Uganda

Stakeholder	Roles & responsibilities
Local community	The local community was involved in the project from the beginning. In community meetings held by the local NGO, people were informed about the potential project and their interest and motivation to participate and contribute resources were assessed. People contributed with land for the infrastructure, some materials for construction and labour during the construction process. In a participatory process, the terms of operation were defined (e.g. water tariffs, opening hours, etc.) and a water kiosk committee was elected. Additionally, the households received WASH training by the local NGO.
Primary school	The teachers of the primary school were responsible for implementing the comprehensive WASH education curriculum for pupils of the schools that was introduced in parallel to the WASH trainings at household level. All the water kiosks were located on school premises and school children had free access to drinking water. Also, handwashing facilities were constructed. Apart from that, the school was represented in the kiosk committee.
Kiosk committee	The kiosk committee was elected by the community and contained representatives from the community and the primary school. It was responsible for the daily operation of the kiosk, minor maintenance work, book-keeping, security and communication to the community. Furthermore, they were the direct contact partner of the local NGO.
Local mechanics	The kiosk committee could contact the local mechanics to carry out minor repairs and maintenance tasks. They lived near the kiosks, were quickly available and they were trained by the Nalwire Technical Institute.
Governmental Authorities	Government officials on local, district and national levels were informed about the activities. The authorities gave the necessary permissions for the construction of the infrastructure and the water abstraction. Regular information exchange meetings were conducted with the authorities and a programme to build the capacity of technical decisions on GDM installation and maintenance was conceptualised and implemented.

Stakeholder	Roles & responsibilities
Local NGO	The local NGO was the direct contact partner of all stakeholders and implementing partners. One pillar of the project was the WASH training, given by the local NGO to the households in the project area. The other pillar was the construction of the GDM kiosks coordinated by the local NGO, which managed and supervised all the field activities. In addition, they organised and held the necessary meetings with the local community and the authorities, organised the craftsmen and supervised the construction, trained the kiosk committee in book-keeping and O&M, were responsible for larger maintenance work, conducted the monitoring, including water quality analysis, and reported the project progress to Eawag.
Nalwire Technical Institute	This is a local school for technicians. Experts from the Institute were trained on kiosk maintenance and repair procedures. They now provide technical support to the water kiosks for major and minor technical maintenance and repairs on the water treatment system. They also trained the local mechanics.
Eawag	Eawag was responsible for the overall planning, monitoring and funding of the project, design of the treatment system and for defining the framework of the collaboration with the local NGO. We assisted the local NGO and Nalwire Technical Institute in technical questions during the planning, construction and operation phases. During various field trips, we extensively trained staff members of the local NGO and the Nalwire Technical Institute in maintenance work and water quality monitoring. Remote technical support was provided during the whole project.



## 4 Enabling environment

We strongly advocate for a holistic approach when planning a drinking water project; the focus should not only be on the technical aspects. The CLUES (Community-Led Urban Environmental Sanitation Planning) guidelines (Lüthi et al., 2011) provide a well proven framework around the concept of "enabling environment" with a participatory approach to involve the community in the planning process (see Figure 61). The six components of an enabling environment are (described in more detail in Lüthi et al., 2011):

1. **Government Support:** Is increased access to safe water for all recognised by the government? Is the project in-line with the government's socio-economic development policy?
2. **Legal & Regulatory Framework:** Is the project in-line with national laws? Tariff regulations, quality regulations, land tenure legislation, building codes, etc.?
3. **Institutional arrangements:** Are the roles and responsibilities of the different stakeholders (household, community based organisations, local & national government, NGOs and private sector) defined?
4. **Skills and Capacity:** Are adequate capacities (project administration, mediation, engineering, construction, and long-term operation and maintenance) established to implement and sustain the project?
5. **Financial Arrangements:** Are resources available to cover the costs for implementation, operation and long-term maintenance? What is the contribution of the users? The possibility of raising funds locally? Is micro-financing possible?
6. **Socio-cultural Acceptance:** Does the technology fit into the local environment and is it accepted by the users? Is the majority of the community willing to participate?



Figure 61: Enabling Environment (Lüthi et al., 2011)



Even if a project does not entirely satisfy all six components, this should not stop it. However, the enabling environment is an excellent tool to use to ascertain, what the strengths and weaknesses and the potential risks of a project are. The weaknesses can be improved upon and the risks monitored as part of a project.

# References

- Ahuja, A. (2017). "Dispensers for Safe Water: An Updated Review of the Evidence." Evidence Action. Retrieved 19.05.2020 from <https://www.evidenceaction.org/dispensers-for-safe-water-an-updated-review-of-the-evidence/>.
- Akhondi, E., et al. (2015). "Gravity-driven membrane filtration as pretreatment for seawater reverse osmosis: linking biofouling layer morphology with flux stabilization." *Water Research* 70: 158-173.
- Anderson, J. and C. Markides (2007). "Strategic innovation at the base of the pyramid." *MIT Sloan management review* 49(1).
- Coerver, et al. (2021). "Compendium of Water Supply Technologies in Emergencies". German WASH Network (GWN) & University of Applied Sciences and Arts Northwestern Switzerland (FHNW), Berlin, Germany. [https://www.humanitarianresponse.info/sites/www.humanitarianresponse.info/files/documents/files/gwn\\_emergency-water-compendium\\_2021.pdf](https://www.humanitarianresponse.info/sites/www.humanitarianresponse.info/files/documents/files/gwn_emergency-water-compendium_2021.pdf)
- Boulestreau, M., et al. (2012). "Operation of gravity-driven ultrafiltration prototype for decentralised water supply." *Desalination and water treatment* 42(1-3): 125-130.
- Chandel, S., et al. (2015). "Review of solar photovoltaic water pumping system technology for irrigation and community drinking water supplies." *Renewable and Sustainable Energy Reviews* 49: 1084-1099.
- Clasen, T. and P. Edmondson (2006). "Sodium dichloroisocyanurate (NaDCC) tablets as an alternative to sodium hypochlorite for the routine treatment of drinking water at the household level." *International Journal of Hygiene and Environmental Health* 209(2): 173-181.
- Doran, P. M. (2013). "Chapter 11 - Unit Operations. *Bioprocess Engineering Principles* (Second Edition)". London, Academic Press: 445-595.
- Fan, G., et al. (2016). "Influence of membrane materials and operational modes on the performance of ultrafiltration modules for drinking water treatment." *International Journal of Polymer Science* 2016.
- Foster, T., et al. (2020). "Functionality of handpump water supplies: a review of data from sub-Saharan Africa and the Asia-Pacific region." *International Journal of Water Resources Development* 36(5): 855-869.
- Gärtner, N., et al. (2021). "Keeping water from kiosks clean: Strategies for reducing recontamination during transport and storage in Eastern Uganda." *Water research X* 10: 100079.
- Gradl, C. and C. Knobloch (2010). "Brokering Inclusive Business Models." *United Nations Development Programme*.
- Jain, R. (2019). "Passive membrane filtration systems." University of British Columbia. Retrieved 24.06.2020 from <https://open.library.ubc.ca/collections/ubctheses/24/items/1.0378177>.
- Kanangire, O. (2013). "Laboratory validation of low-cost methods for the measurement of E. coli and total coliforms", Unesco-IHE.

- Karamchandani, A., et al. (2009). "Emerging Markets, Emerging Models." Monitor Group Company.
- Kiprono, A. W. and A. I. Llarío (2020). "Solar Pumping for Water Supply: Harnessing solar power in humanitarian and development." Practical Action Publishing, Rugby, UK. <http://dx.doi.org/10.3362/9781780447810>
- Lee, D., et al. (2019). "Effect of membrane property and feed water organic matter quality on long-term performance of the gravity-driven membrane filtration process." *Environmental Science and Pollution Research* 26(2): 1152-1162.
- Levy, K., et al. (2014). "Household effectiveness vs. laboratory efficacy of point-of-use chlorination." *Water Research* 54: 69-77.
- Lockwood, H. and S. Smits (2011). "Supporting rural water supply: moving towards a service delivery approach." Practical Action Publishing. <https://doi.org/10.3362/9781780440699>. ISBN: 1853397296
- Lüthi, C., et al. (2011). "Community-Led Urban Environmental Sanitation Planning: CLUES." Eawag/Sandec, WSSCC, UN-HABITAT,
- McLaughlin, L. A., et al. (2009). "An observational study on the effectiveness of point-of-use chlorination." *Journal of environmental health* 71(8): 48.
- Meierhofer, R., et al. (2018). "From water source to tap of ceramic filters—Factors that influence water quality between collection and consumption in rural households in Nepal." *International journal of environmental research and public health* 15(11): 2439.
- Meierhofer, R., et al. (2017). "Membrane filtration reduces recontamination risk in chlorinated household water containers." 40th WEDC International Conference. Loughborough, UK. 2595.
- Meierhofer, R., et al. (2019). "Influence of container cleanliness, container disinfection with chlorine, and container handling on recontamination of water collected from a water kiosk in a Kenyan slum." *Journal of water and health* 17(2): 308-317.
- Mellor, J. E., et al. (2013). "Coliform sources and mechanisms for regrowth in household drinking water in Limpopo, South Africa." *Journal of Environmental Engineering* 139(9): 1152-1161.
- MSR (2017). "MSR, Stanford and Path test chlorine dosing prototype in Kenya." Mountain Safety Research. Retrieved 03.03.2020 from <https://www.msrgear.com/blog/msr-stanford-path-chlorine-dosing-kenya/>.
- Oka, P., et al. (2017). "Operation of passive membrane systems for drinking water treatment." *Water Research* 115: 287-296.
- Opryszko, M. C., et al. (2013). "Impact of water-vending kiosks and hygiene education on household drinking water quality in rural Ghana." *The American journal of tropical medicine and hygiene* 88(4): 651-660.
- Orner, K. D., et al. (2017). "Effectiveness of in-line chlorination in a developing world gravity-flow water supply." *Waterlines* 36(2): 167-182.
- Osterwalder, A. and Y. Pigneur (2010). "Business model generation: a handbook for visionaries, game changers, and challengers." John Wiley & Sons, 0470876417

- Pal, P. (2017). "Sustainable Water-Treatment Technology", Chennai. Elsevier. <https://doi.org/10.1016/b978-0-12-810391-3.00010-2>
- Peter, M. (2015). "Gravity-driven membrane disinfection for household water treatment. Final report: GDMD project 2010-2014." Eawag, Duebendorf, Switzerland.
- Peter-Varbanets, M., et al. (2012). "Intermittent operation of ultra-low pressure ultrafiltration for decentralized drinking water treatment." *Water Research* 46(10): 3272-3282.
- Peter-Varbanets, M., et al. (2010). "Stabilization of flux during dead-end ultra-low pressure ultrafiltration." *Water Research* 44(12): 3607-3616.
- Pickering, A. J., et al. (2019). "Effect of in-line drinking water chlorination at the point of collection on child diarrhoea in urban Bangladesh: a double-blind, cluster-randomised controlled trial." *The Lancet Global Health* 7(9): e1247-e1256.
- Pronk, W., et al. (2019). "Gravity-driven membrane filtration for water and wastewater treatment: a review." *Water Research* 149: 553-565.
- RWSN (2019). "The 2019 RWSN directory of rural water supply services, tariffs, management models and lifecycle costs." Skat Foundation, St. Gallen, Switzerland
- Skinner, B. and R. Shaw (1999). "47. Improving pond water." WEDC, Loughborough University, United Kingdom 9781780445816
- Tang, X., et al. (2016). "Effect of operation parameters on the flux stabilization of gravity-driven membrane (GDM) filtration system for decentralized water supply." *Environmental Science and Pollution Research* 23(16): 16771-16780.
- Truttmann, L., Su, Y., Lee, S., Burkhardt, M., Brynjólfsson, S., Chong, T. H., & Wu, B. (2020). Gravity-driven membrane (GDM) filtration of algae-polluted surface water. *Journal of Water Process Engineering*, 36, 101257.
- Wegelin, M. (1992). "Surface Water Treatment by Roughing Filters.", International Reference Centre for Waste Disposal.
- WHO (1997). "Guidelines for drinking-water quality: second edition. Volume 3 Surveillance and control of community supplies." World Health Organization Geneva, Switzerland 92 4 154503 8
- WHO (2017a). "Guidelines for drinking-water quality: fourth edition incorporating the first addendum." World Health Organization, Geneva, Switzerland License: CC BY-NC-SA 3.0 IGO
- WHO (2017b). "Principles and practices of drinking-water chlorination: a guide to strengthening chlorination practices in small-to medium sized water supplies." World Health Organization, Regional Office for South-East Asia, New Dehli, India 978-92-9022-53
- WHO (2021). "The measurement and monitoring of water supply, sanitation and hygiene (WASH) affordability: a missing element of monitoring of sustainable development goal (SDG) targets 6.1 and 6.2." World Health Organization, Geneva, Switzerland
- Wright, J., et al. (2004). "Household drinking water in developing countries: a systematic review of microbiological contamination between source and point-of-use." *Tropical medicine & international health* 9(1): 106-117.

Wu, B., et al. (2017). "Gravity-driven microfiltration pretreatment for reverse osmosis (RO) seawater desalination: Microbial community characterization and RO performance." *Desalination* 418: 1-8.

Yates, T. M., et al. (2015). "Effectiveness of chlorine dispensers in emergencies: case study results from Haiti, Sierra Leone, Democratic Republic of Congo, and Senegal." *Environmental science & technology* 49(8): 5115-5122.

# Appendix

## A Trouble shooting for GDM kiosks in Eastern Uganda

CONSULT THIS PART IN CASE OF ANY DAMAGE OR BREAKDOWN

Objectives:

- Identify hazards that can affect the safety of water in the treatment system or lead to an interruption of water supply
- Troubleshoot in case of breakdown

Explanation:

For each system part, the table describes risks and hazards with their impact and troubleshoot solutions. The probability and seriousness of consequences are estimated in separate columns:

Probability:	Consequences:
Very high: more than once a month	1 - No considerable impact
High: couple of times per year	2 - Minor impact - can be managed within a short time, compliance to standards but no considerable health risk
Medium: once in 1 - 2 years	3 - Major impact - needs time and resources to manage, possible health risk
Low : less than once in 2 - 3 years	4 - Catastrophic - irreversible damage of the system, serious health risk

System Part	Nr	Risk of hazard	Impact	Probability	Consequences	Troubleshoot
<b>1. Intake</b>	1.1	Clogging of the strainer	No water Pump breakdown	High	2	Cleaning of the strainer without dismantling it (see Part II, section 2.4)
	1.2	High turbidity of raw water	Particles in the pump	Medium	3	Improve the filtration performance of the intake (see Part I, 2.2)
	1.3	Damaged pipe (by boats)	No water	Medium	3	Reinforce the lake shore with stones. Control regularly for erosion.
	1.4	Erosion of the lake shore due to sand collection leading to the exposure of the pipe	Damage of the pipe	Medium	3	Reinforce the lake shore with stones. Control regularly for erosion.

System Part	Nr	Risk of hazard	Impact	Probability	Consequences	Troubleshoot
<b>2. Pump house</b>	1.5	Flooding	Increase of turbidity, particles in the pump	Low	2	Observe turbidity. If it increases, stop the pump to avoid damages and wait until the water level lowers
	2.1	Air release valve being plugged	Pump stops	Low	2	Clean air release valve. Replace if not possible to clean
	2.2	Check valve clogging	No water	Low	2	Clean check valve, replace if rusted
	2.3	Pump overheating	Pump breakdown	Low	3	Replace the pump
	2.4	Solar panels stolen	No electric supply	Low	3	Replace solar panels
	2.5	Solar panel dirty/ covered with leaves	No electric supply	High	2	Clean solar panels with water or soft cloth. Do not use any abrasive materials, soap or surfactants (see Part II, section 3.1)
	2.6		No electric supply	Medium	2	Check cable connections and tighten them
	2.7	Loose pump connections	Water spilling, no water in tanks	Low	2	Tighten connections. If does not help, replace the flexible tubes
	2.8	Pump configuration problems (battery mode)	Pump stops	High	2	Restart the pump in solar mode.
	2.9	Pump configuration problems which cannot be solved by resetting	Pump stops	High	2	Connect a laptop and check configuration of the sensors. Restart the pump afterwards.
	2.10	Lightening	Damage of solar panels or the pump	Low	3	Replace the solar panels and the pump
2.11	Flooding	Pump breakdown	Low	3	If the pump is not yet flooded: monitor the water level in the pump house and remove the pump in case there is a danger of flooding the pump. Lift cables from the solar panel up. If the pump house is flooded, wait till water level dropped down until you restart operation. Switch off the pump by using the flow switch and do not start until dry. Let it dry for up to 1 week before testing it. Replace if damaged.	

System Part	Nr	Risk of hazard	Impact	Probability	Consequences	Troubleshoot
<b>3. Pipes</b>	3.1	Air release valve being plugged	Low flow rate to the pump or no water at lower sunshine intensity	Medium	2	Replace the valve and release accumulated air
	3.2	Biofilms, Sediments	Low flow rate and possible taste and odour problems of the incoming water.	Low	3	Remove check valve in the pump house and flush the pipe back to the lake. Leave overnight and start pumping again controlling the air is not plugging the system.
	3.3	Illegal connections	Water loss (low flow rate at the tank)	Low	2	Close illegal connection
	3.4	Damage	No water	Low	2-3	Find and replace damaged place
	3.5	Stolen connections	No water	Medium	2	Replace and cover/protect the new connections
<b>4. Raw water tank</b>	4.1	Leaking connections	Water loss and water on the ground	Medium	2	Fix connections by tightening them, open/close or using silicon. If not possible - replace. Do not touch connections regularly and protect them from damage
	4.2	Fundament cracking	Destabilization of the water tank	Low	2	Check fundament for cracks. Fix cracks by cement or reinforce the fundament if needed.
<b>5. Rain water harvesting</b>	5.1	Gutters are damaged by storm	No rain water in the tank, water accumulation on the ground	Medium	1	Find and fix rain water gutters.
	5.2	Too much water	Overflow of the gutters, accumulation of water on the ground	Low	1	Clean gutters. Place a stopper to stop collecting water from a part of the roof.
	5.3	Gutters clogged	Overflow of the gutters, no water in the tank	High	1	Clean gutters
<b>6. Membrane tank</b>	6.1	Deformation	Overflow over top	Low	2	Check state of supporting structures in the tank. Fix them if needed.
	6.2	Membrane clogging	Low filtration rate or no water passing through the tank	Medium	2	Flush the membrane tank (see Part II, section 4.3.1)
	6.3	Too much sediments, too low oxygen	Low filtration rate and taste and odour compounds	High	2	Flush both raw water tank and membrane tank. Repeat if necessary (see Part II, section 4.3.1)



System Part	Nr	Risk of hazard	Impact	Probability	Consequences	Troubleshoot
7. Clean water tank	6.4	Broken or leaking connections	No water in the tank, or water around on the ground Risk of contamination	High	2-3	Replace broken connections. Fix connections by tightening them, open/close or using silicon. If not possible - replace.
	6.5	No lid	Contamination, risk of drowning for climbing children	Low	1	Replace and close the lid.
	6.6	No lid	Risk of drowning for climbing children	Low	4	Replace and close the lid
	6.7	Complete drying of the system if no water in the membrane tank	Complete irreversible clogging of the membranes, irreversible breakdown	Low	4	Irreversible breakdown. Cannot be repaired.
	6.8	Leakage of the membrane	Microbial contamination of clean water	Low	3	Monitor water quality. If consistently bad results, disinfect clean water tank and control water quality again (see Part II, 4.3.3). Tighten connections of the module (see Part II, section 4.3.2) by an expert. If membrane material is damaged it cannot be replaced. If only one module is damaged, the others can still be used.
	7.1	Damage of supporting structures	Overflow over top of the tank, microbial safety risk	Medium	2	Fix the supporting structures
	7.2	Deformation of the tank by heat and sun exposure	Overflow over top of the tank, microbial safety risk	Medium	3	Replace the tank or construct a roof over the tank
	7.3	Missing lid	Microbial safety risk	Medium	3	Replace the lid and disinfect the tank if needed (see Part II, section 4.3.3)
	7.4	Unknown contamination	Microbial safety risk	Medium - high	3	Disinfect the clean water tank (see Part II, section 4.3.3)
	7.5	Leaking or broken connections	No water in the tank, or water around on the ground			

System Part	Nr	Risk of hazard	Impact	Probability	Consequences	Troubleshoot
8. Pipeline to water kiosk	7.6	Overdose chlorine	Taste and smell of chlorine in water	High	1	Reduce the dosing of the chlorinator
	7.7	Underdose chlorine	Microbiological contamination or recontamination at household level	Very high	1	Test water. Increase dose of chlorine to avoid recontamination
	8.1	Pipe breakdown	Water loss, contamination	Low	2	Replace the pipe. Protect the area.
9. Water kiosk	8.2	Illegal water use from sample taps	Water loss, loss of income	Low	1	Control locks on the taps and any other connections. Replace locks if broken.
	9.1	Illegal water use	Water loss, loss of income	Low	1	Control locks on the taps and any other connections. Replace locks if broken.
	9.2	Broken taps	Increase of time required to fill jerrycans	Medium	2	Replace taps
10. Infiltration trench	9.3	Spill water accumulation around kiosk building	Standing water damaging infrastructure	High	2	Improve infiltration trench or reduce spilling by reminding people to close taps
	10.1	Clogging	Standing water (mosquitoes)	Low	2	Clean infiltration trench by removing the top soil and replacing the stones.
	10.2	Lower permeability of soil than expected	Overflow	Low	2	Increase the size of infiltration trench
	10.3	Too small size	Overflow	Low	2	Increase the size of infiltration trench

## B Manuals for operators of GDM kiosks in Eastern Uganda

### 1. Clean the strainer



Every 2 weeks



30 min



- ◇ Brush
- ◇ Sponge

1. Stop the pump



2. Take out the strainer from the lake

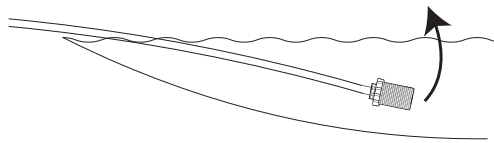

3. Clean the outer grid with the sponge or brush

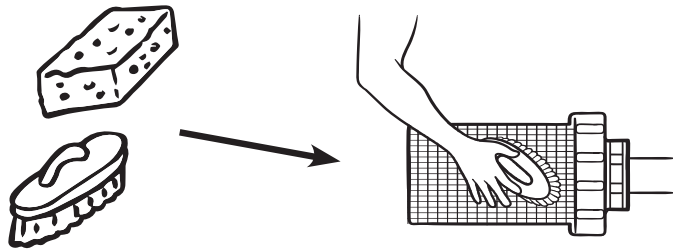

4. Remove the outer strainer

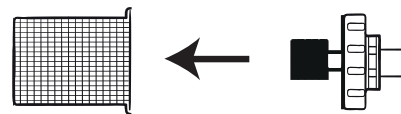

5. Clean the inner strainer and check for damage. It should look like on the picture

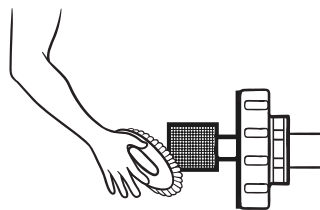

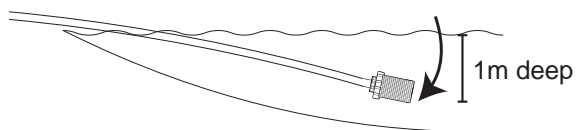

6. Put the outer grid back and place the strainer back in the lake (1m deep)

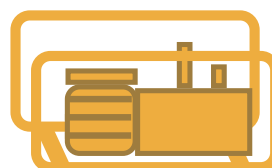

7. Start the pump again



## 2. Clean the solar panel

 Every month  
 1 h  

- ◇ Cloth/sponge
- ◇ Ladder
- ◇ Jerry can with water

1.

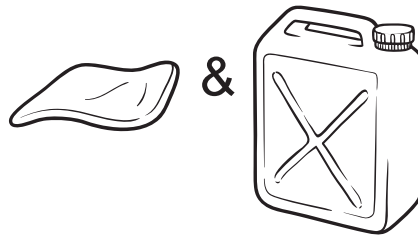

2.

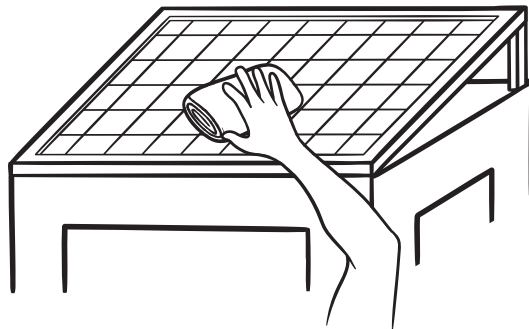

**No soap, no hard material.  
Do not scratch!  
Use clean water!**



### 3. Flush the membrane tank



Every month



2.5 h



◇ Spanner



1. The tank needs to be at least 3/4 full.

Close the **raw water tank valve** and the **clean water tank valve** with a spanner.

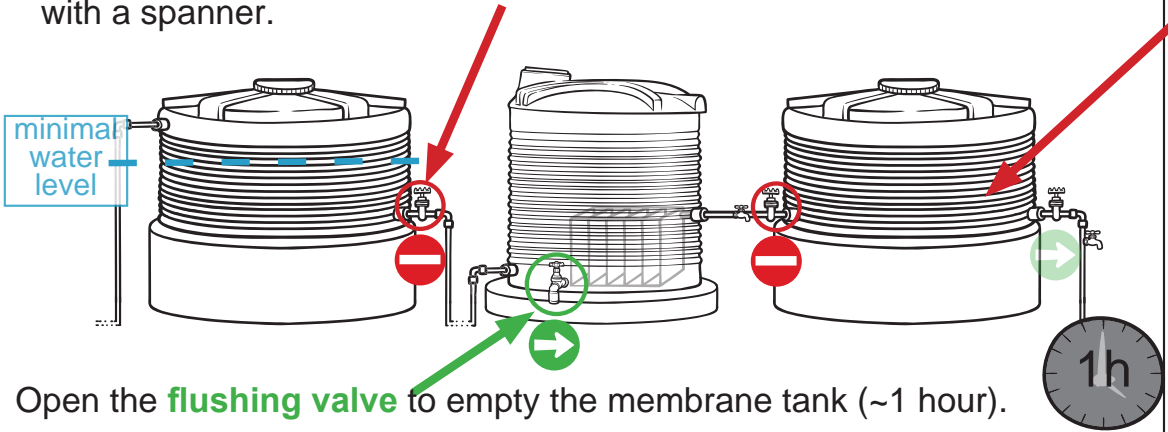

2. Close the **flushing valve** and open the **raw water tank valve**

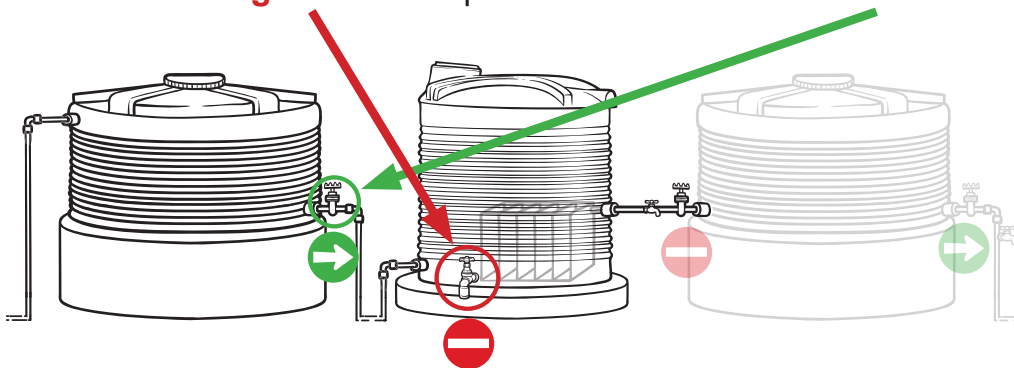

3. Wait for ~1 hour. Then open the **clean water tank valve**

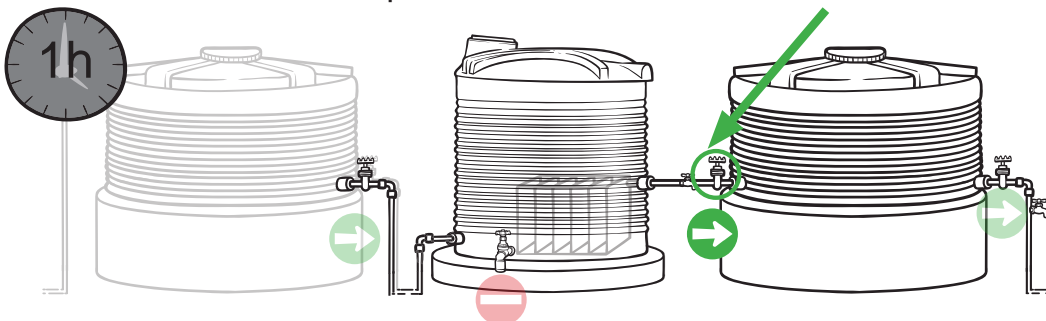

**Immediately refill the membrane tank with water after flushing. Drying damages the membranes!**

## 4. Disinfect the clean water tank



Every 2 months



5 h



- ◇ Spanner
- ◇ Jerry can
- ◇ 0.5L PET bottle
- ◇ Knife 
- ◇ Chlorine powder

1. The tank needs to be at least 1/3 full. Close the **clean water tank valve** and the **outlet**.

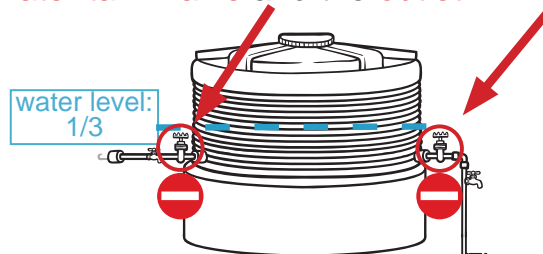

3. Cut the 0.5L PET bottle to make a doser. Add 100g of chlorine powder (4cm) in the doser

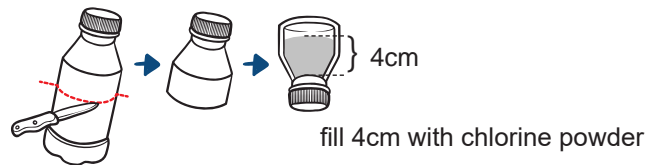

4. Mix clean water with the chlorine in a jerry can and pour the jerry can with the chlorine in the clean water tank. Mix the tank with a clean stick

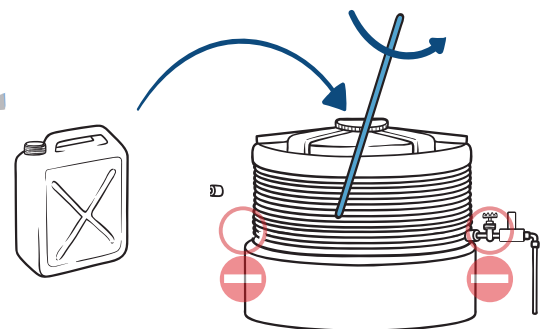

5. Wait at least 3 hours



6. Open the **outlet** to flush all the water from the clean water tank

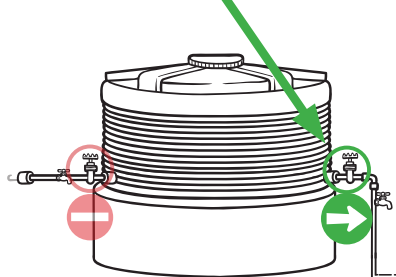

7. Open the **clean water tank valve** to start operation again

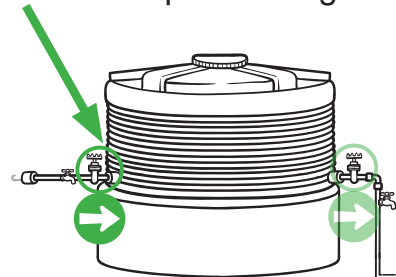

**BE CAREFUL** handling chlorine. Wash hands. Do not drink. No children!

## 5. Yearly service of membranes



Every year



4 h



- ◇ Spanner
- ◇ Ladder
- ◇ Broom
- ◇ Sponge/cloth
- ◇ Jerry can
- ◇ Screw driver
- ◇ Spare clamps
- ◇ Spare screws

1. The tank needs to be at least 3/4 full. Close all the valves of your system to isolate every tank.

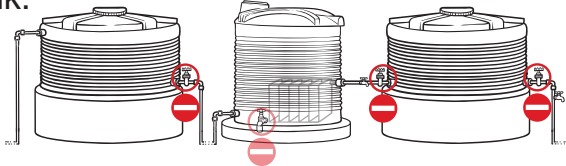

2. Flush the membrane tank by opening the **flushing valve** at the bottom of the tank.

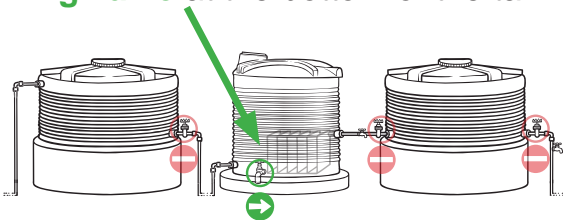

3. Use a ladder to enter the tank. Clean the tank from remaining sediments at the bottom by using a brush or broom, sponges or clothes and a jerry can. Be careful that you do not touch the membrane module while cleaning the tank!

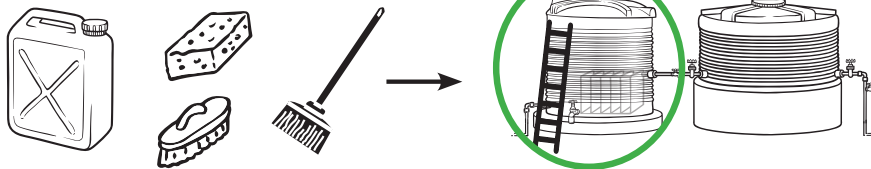

4. Check the connections of the membrane module.

- Are they tight?
- Are hose clamps rusty?
- Are the screws tight?



Change rusty or damaged parts if necessary and tighten all the screws.

5. Close the **flushing valve** and open the **raw water tank valve**

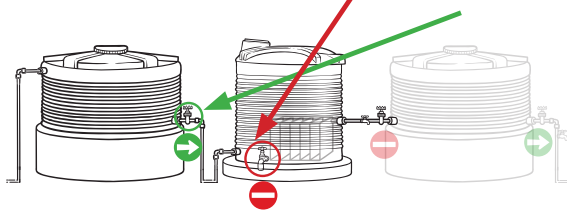

6. Wait for ~1 hour. Then open the **clean water tank valve**

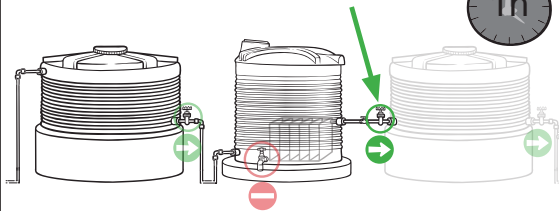

## 6a. Direct membrane integrity - field work

Steps that need to be carried out in the field

1. Spike solution: Mix a PET bottle of water (bottled water) with probiotic pills (e.g. Bioflorin®). Use approximately 1.5 pills/m<sup>3</sup> of raw water (e.g. tank volume = 6m<sup>3</sup>, → 9 pills).

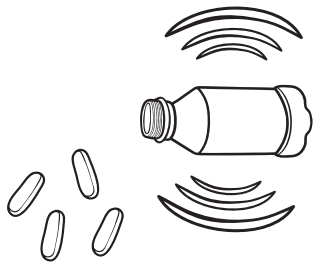

3. Wait 10 min, mix the membrane tank again

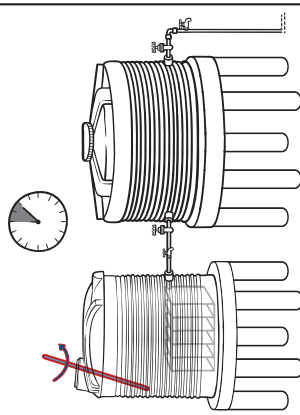

2. Add the solution stepwise to the membrane tank. While doing so, mix the water with a clean stick.

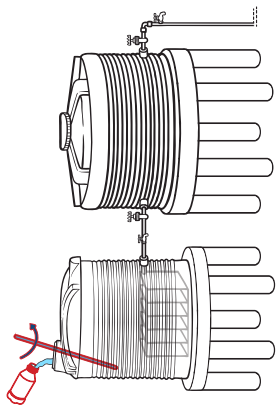

4. Take a sample of the raw water with a sterile bottle or sampling bag.

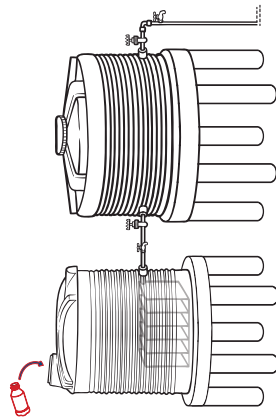

5. Wait 1 h to let the system filtrate

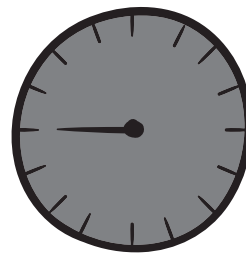

6. Collect a sample of the permeate water from the pipe connecting the membrane tank with the clean water tank. Leave the tap open for 10 sec before taking a sample.

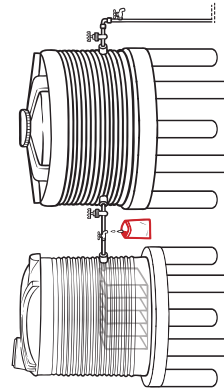

Every year



1. day: 3-4 h



- ◇ Bioflorin
- ◇ PET bottle
- ◇ sampling bottle
- ◇ sampling bags



## 6b. Direct membrane integrity - laboratory work

Steps that need to be carried out in the laboratory

- Mix the bottle with the raw water properly, pipette 1ml of raw water on an ETC dry plate and incubate it for 24h.

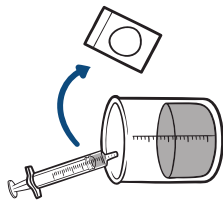
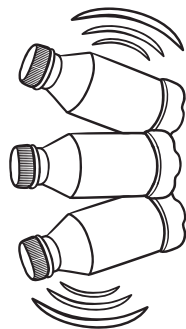

- Place a sterile filter on the filtration funnel and filter 100ml of the permeate water. Place the filter on an ETC compact dry plate and incubate it for 24h.

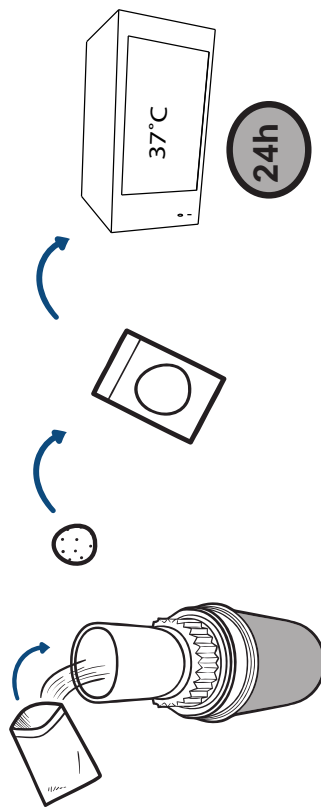

- Count the colony forming units on both plates. Multiply the number of colonies counted on the plate with raw water by 100 to compare it to the count of colonies on the plate with the permeate water.

CFU/100ml permeate water

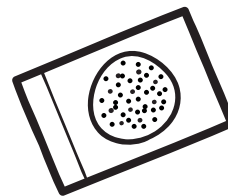

x 100

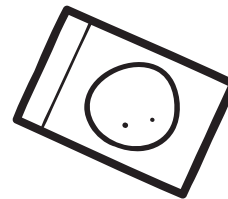

Every year



2. day: 2h



- ◇ Pipette (1-5ml)
- ◇ ETC Compact dry plates
- ◇ funnel
- ◇ membrane filters
- ◇ tweezers
- ◇ sterile water
- ◇ hand sanitizer
- ◇ incubator

## 7a. Indirect membrane integrity - field work

Steps that need to be carried out in the field

1. Mix the membrane tank thoroughly with a clean stick.

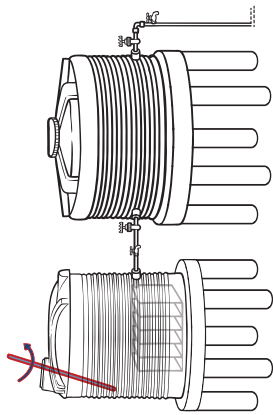

2. Take a sample from the raw water tank using a sterile bottle or sampling bag.

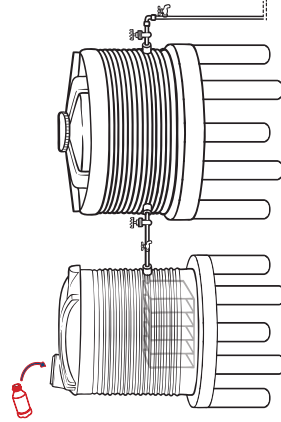

3. Take a sample from the pipe, connecting the membrane tank with the clean water tank (permeate water). Leave the tap open for 10 sec before taking the sample.

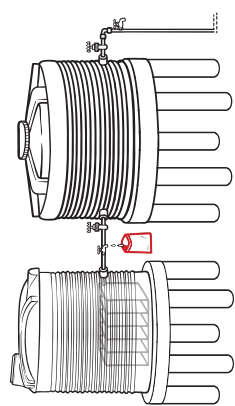

Every year



1. day: 1 h



- ◇ sampling bottle
- ◇ sampling bags

## 7b. Indirect membrane integrity - laboratory work

Steps that need to be carried out in the laboratory

7. Mix the bottle with the raw water properly, pipette 1ml of raw water on an EC dry plate and incubate it for 24h.

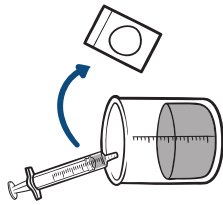
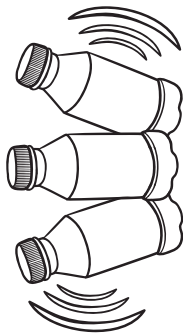

8. Place a sterile filter on the filtration funnel and filter 100ml of the permeate water. Place the filter on an EC compact dry plate and incubate it for 24h.

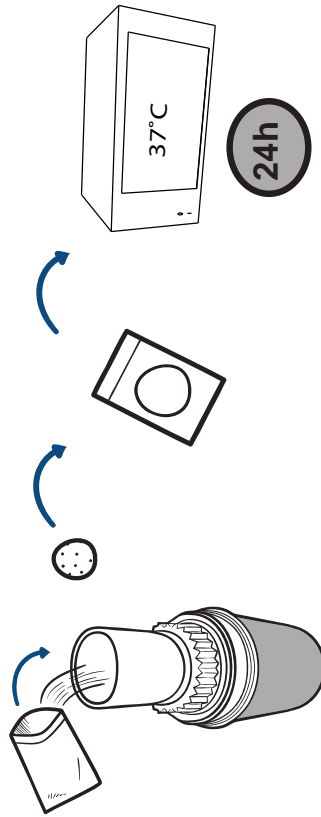

9. Count the colony forming units of total coliforms (purple dots) on both plates. Multiply the number of colonies counted on the plate with raw water by 100 to compare it to the count of colonies on the plate with the permeate water.

$$\frac{\text{Number of colonies on raw water plate}}{\text{Number of colonies on permeate water plate}} \times 100 = \text{CFU} / 100 \text{ml permeate water}$$

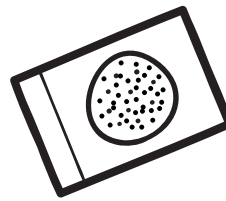

x 100

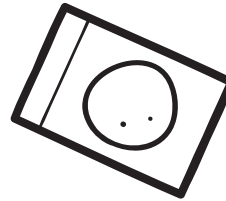

Every year

2. day: 2h

◇ Pipette (1-5ml)

◇ EC Compact dry plates

◇ funnel

◇ membrane filters

◇ tweezers

◇ sterile water

◇ hand sanitizer

◇ incubator

# C T-chlorinator: Building instructions and user manual

## 1. Description

The T-chlorinator consists of a cylinder with small holes that is placed into a T-fitting. It is installed in-line before or after the drinking water reservoir. The cylinder contains slowly dissolving TCCA tablets (diameter = 1 inch), which are eroded by the flow of water. To adjust the dosage the number of tablets can be altered. Alternatively, different cylinders with different numbers and sizes of holes can be manufactured and can easily be exchanged. If the raw water quality, the flow rate or target concentrations vary significantly, a by-pass pipe can be installed to increase dosing flexibility. With constant raw water quality and a static target concentration the presented T-chlorinator provided a relatively stable chlorine dose for flows from 5 - 20L/min. At a flow of less than 5L/min, the chlorine concentration can increase to 4 mg/L. Above flows of 20L/min, the chlorine concentration decreases.

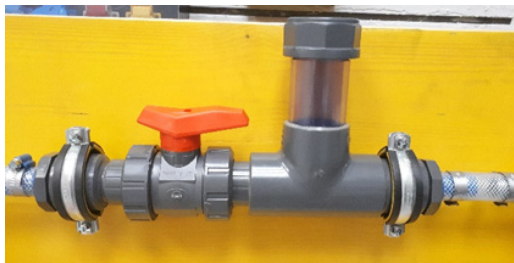

Figure 62: T-chlorinator in the laboratory at Eawag

### Chlorine tablets

Use slowly dissolving size 1-inch TCCA (trichloroisocyanuric acid) tablets, which are suitable for drinking water treatment. Handle the tablets with care! Tablets intensify fire and are harmful to skin, eyes and respiratory track. Store them in a dry, well-ventilated place and keep the container tightly closed.



Read the safety data sheet of the product!

## 2. Building instructions

The main parts of a T-chlorinator are a PVC ball valve, a PVC T-fitting, extended with a PVC pipe, closed with a removable, threaded lid. A smaller PVC pipe, the cylinder, is inserted into the T-fitting. The cylinder is closed tightly (glued) at the bottom with a PVC plate and has a removable, threaded lid at the top. Assure that you use a food-safe (NSF/ANSI 61) glue. Small holes in the cylinder regulate dosing. Below, we present a specific construction design for a T-chlorinator. The dimensions and diameters of the parts as well as the coupler fittings can be adapted.

The parts needed to build a T-chlorinator are presented in Table 7. Please note that the couplings of the end caps should be threaded. Otherwise, it's difficult to connect the chlorinator to PE pipes. Threaded or glued connections can be used. All parts used can usually be found in a hardware store or on local markets.

Table 19: Parts needed to build a T-chlorinator

	Casing
1	Ball valve, 50 mm, PVC, female threaded or glued
1	Nipple, 50 mm, PVC
1	T-fitting, 50 mm, PVC, threaded or glued
1	PVC coupler, 50 mm, [threaded or glued] - [glued]
1	PVC coupler, 50 mm, [threaded or glued] - [threaded]
1	PVC pipe, 47 mm, length: 7 cm
1	PVC end cap, 50 mm, <b>threaded</b>
2	PVC-PE coupler, 50 mm, (evt. reducing bush) or alternative connection to pipe

Cylinder	
1	PVC pipe, 33mm, length: 17 cm
1	PVC plate, 33mm, glued at the bottom of cylinder
1	PVC coupler, 36mm, [threaded or glued] - [threaded]
1	PVC end cap, 33mm, <b>threaded</b>

Connect the parts as presented in Figure 63. Use Teflon tape for threaded connections and PVC glue (NSF/ANSI 61) for glued connections.

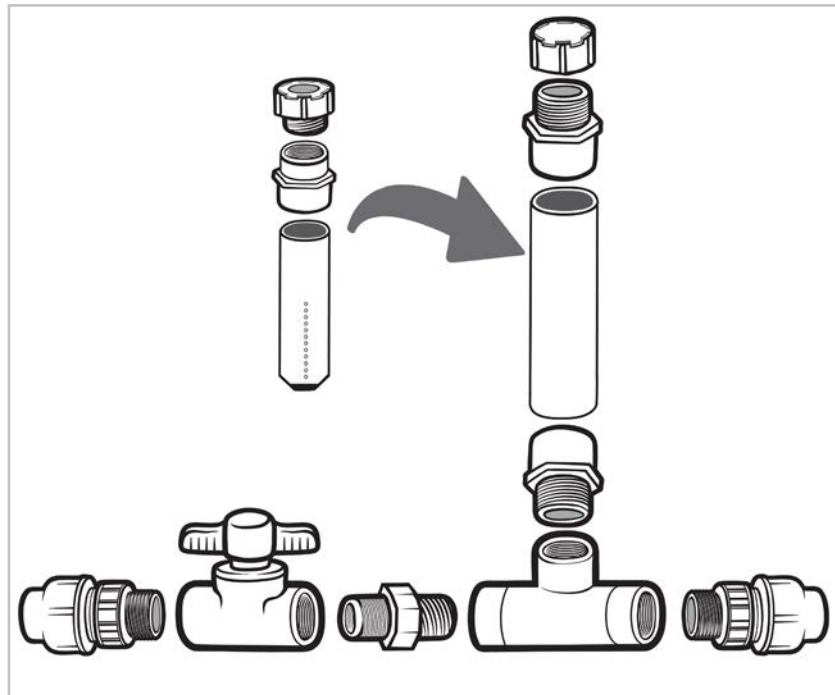

Figure 63: Assembly of the T-chlorinator parts

#### Cylinder

- Make angles at the bottom to fix position in T-fitting
- Drill small holes in the direction of flow:
  - » 1 ppm cylinder: every 2.5mm a 1 mm hole
  - » 2 ppm cylinder: 2 x 4 mm holes at the bottom, in addition to 1 mm hole every 2.5mm



Figure 64: Holes in cylinder

### 3. Installation

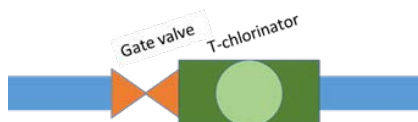

Figure 65: Standard installation: view from top

Standard installation: Connect the T-Chlorinator in-line before the point of water collection. To connect it use suitable male threaded connectors (e.g. PE-PVC connectors for PE pipes, see Figure 65).

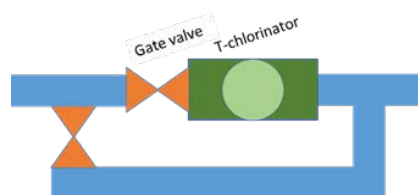

Figure 66: By-pass installation: view from top

By-pass installation: Install a by-pass with T-fittings (see Figure 66) if your flow rate is highly variable or below 5L/min, or if you want to adjust the dosage without changing the cylinder.

#### 4. Operation

In the morning: Insert the cylinder filled with chlorine tablets into the T-chlorinator. Then open the gate valve so that the water reaches the taps.

In the evening: Close the gate valve, remove cylinder and store it in a well-ventilated, dry place.

- » If water is stagnant in the chlorinator for more than 30 minutes, close the gate valve and remove the cylinder. Put it back, once the water is running again. Otherwise, the chlorine tablets keep dissolving and the chlorine concentration in the water gets too high.



Figure 67: T-chlorinator and cylinder

#### Refill chlorine tablets:

1. Close the gate valve.
2. Fill the cylinder with size 1 inch slowly dissolving TCCA chlorine tablets. **USE GLOVES! If the skin gets in contact with chlorine, immediately wash it thoroughly with soap!**
3. Close the lid of the cylinder
4. Place the cylinder inside the T-chlorinator and close its lid
5. Open the gate valve



Regularly check the chlorine concentration at the water tap with a pool tester and DPD1 tablets. WHO recommends a free residual chlorine concentration of 0.2 - 0.5 mg/L at the point of consumption.

# D AkvoTur: Building instructions and user manual

## 1. Description

The AkvoTur is a chlorinator that erodes chlorine tablets. It can be installed directly at the tap, right before water is collected, or at the inlet of the clean water reservoir. The device consists of a closable (NOT airtight) vessel with a PVC plate at the bottom, where a PVC pipe can be placed. The pipe has slits, where water can enter and erode the chlorine tablets that sit inside. To adjust the dosage, the PVC pipe can be turned. If the slits are in the direction of flow, the concentration is highest (ca 3 mg/l). If the slits are 90° to the direction of flow, the concentration is lowest (ca 0.5 mg/l). Over varying flow rates (1 - 6 L/min), the dosage is constant. If the flow exceeds 12 L/min the device overflows.

### Chlorine tablets

Use slowly dissolving size 1-inch TCCA (trichloroisocyanuric acid) tablets, which are suitable for drinking water treatment. Handle the tablets with care! Tablets intensify fire and are harmful to skin, eyes and respiratory track. Store them in a dry, well-ventilated place and keep the container tightly closed.

Read the safety data sheet of the product!



## 2. Building instructions

The AkvoTur consists of a vessel (ca. 1 L volume) with an inflow and an outflow. In the centre, a PVC plate is fixed at the bottom using screws. On this plate, a PVC pipe with 2 mm slits can be placed and turned.

Table 20: Parts needed to build an AkvoTur

1	Small vessel with lid (Ø = ca 9cm, height = ca 15cm)
2	elbows (½" or ¾")
2	Bulkheads/tank connections (½" or ¾")
1	PVC pipe (1 inch), ca 10 cm --> tablets need to fit inside
2	screws (to fix plate at the bottom)
1	rubber sealing
1	PVC plate -> see drawing! or 2 cylinders: PVC-PE coupler, 50mm, (evt. reducing bush) or alternative connection to pipe

Connect the parts as presented in Figure 69. Use Teflon tape for threaded connections. To fix the plastic base, screw it from the bottom with a rubber sealing to avoid leaking. Alternatively use a glue to fix the plate.

However, make sure you use a suitable, food-grade (NSF/ANSI 61) glue as with PVC glue it is not possible to glue other plastics. Use a milling cutter to cut two opposing slits in the pipe (ca 8cm high, starting at the very bottom).

The PVC plate (see Figure 68) can either be prepared from one

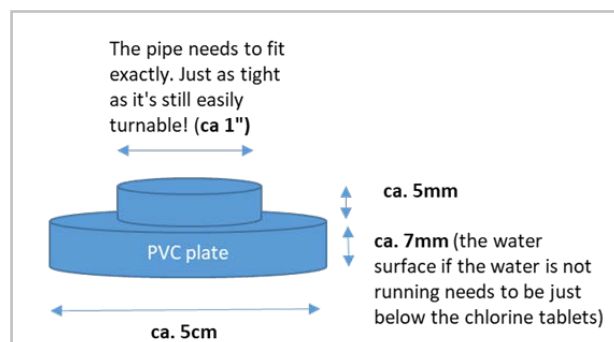

Figure 68: Plate of the Akvotur

PVC piece using a lathe, or from two cylinders that are screwed or glued together. It's essential, that the PVC pipe with the slits fits exactly the PVC plate and can be rotated. Use a thread cutter to make the screws in the PVC plate.

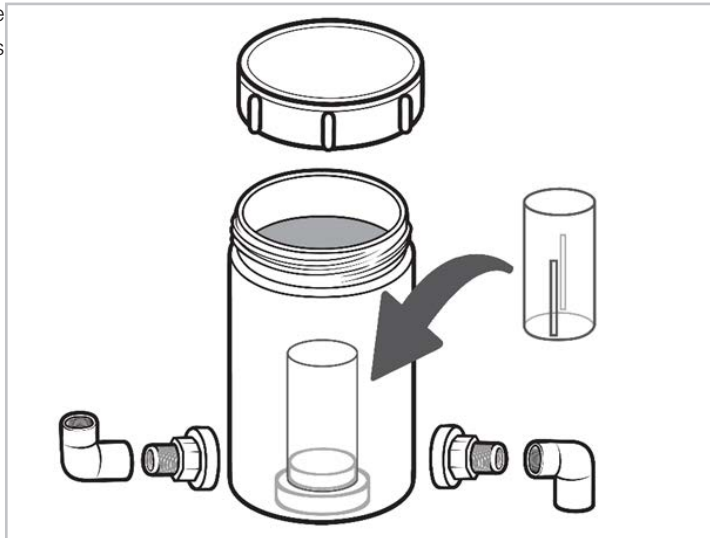

Figure 69: Assembly of the AkvoTur parts

### 3. Installation

**Tap-attached:** Connect the AkvoTur at the tap of the water kiosk. You need a 1/2" or 3/4" male thread (depends on connectors used for the AkvoTur, see Figure 70). Slightly bend the pipe ahead of the tap downwards so that the PVC plate is dry when water is not flowing and the chlorine tablets are not in contact with water (See Figure 70)

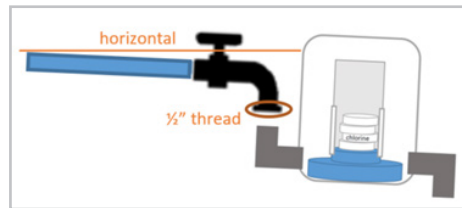

Figure 70: Tap-attached installation

**Pre-Reservoir:** Alternatively, the AkvoTur can be installed at the inlet of the clean water reservoir (see Figure 71). Like in the tap-attached set-up, slightly bend the pipe downwards. It has to be guaranteed that the device is easy accessible to refill the chlorine tablets.

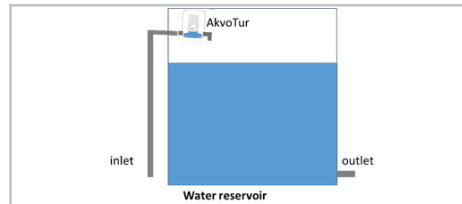

Figure 71: Tap-attached installation

### 4. Operation

After installation, adjust the pipe for the desired dosing. (e.g. to dose 2 mg/l, place the pipe that the slits are 22.5° from the inflow, Figure 72). Make sure there are always chlorine tablets inside the device. Regularly check the chlorine concentration at the water tap with a pool tester and DPD1 tablets. WHO recommends a free residual chlorine concentration of 0.2 - 0.5mg/L at the point of consumption.

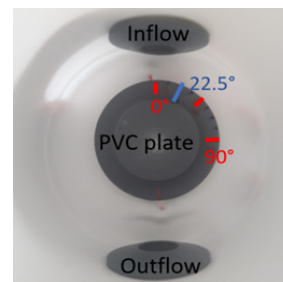

Figure 72: Inside view from top

Refill chlorine tablets:

1. Close the water flowing through the AkvoTur
2. Fill the PVC pipe with 1-inch slowly dissolving chlorine tablets. **USE GLOVES! If the skin gets in contact with chlorine, immediately wash it thoroughly with soap!**
3. Now the AkvoTur is ready and the water can be opened again.





## E Taking a water sample

### With a Whirl Pak ® (see Figure 73)

- Before collecting water samples, disinfect your hands with the hand sanitizer.
- Before taking a sample at a tap: Disinfect the tap with a swipe of 80% Ethanol or flame it, then open the tap and let the water run for 5 - 10sec
- If the bag is too full, dump a bit of water without touching the opening
- Place the sample into the cooler bag/box and keep it cool and dark until analysed. Analysis should be conducted within 6 hours.

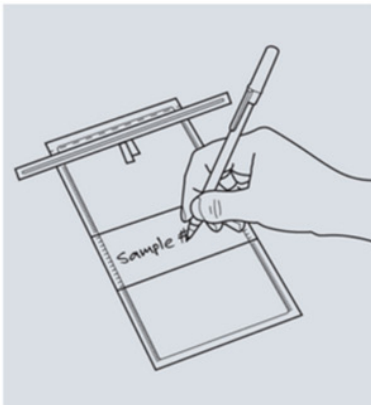

1. Label your sample

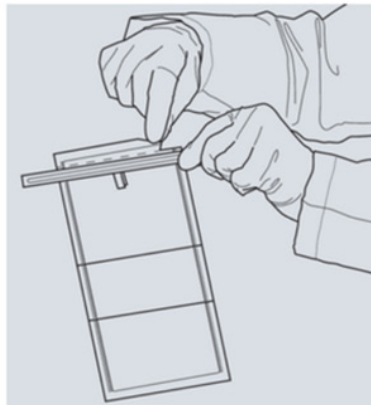

2. To open the bag, tear off the top along the perforation

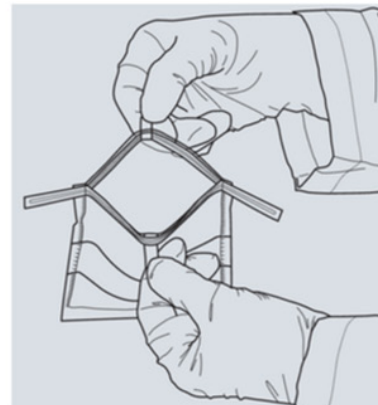

3. Use the pull tabs to open the bag. Never touch the inside of the bag!

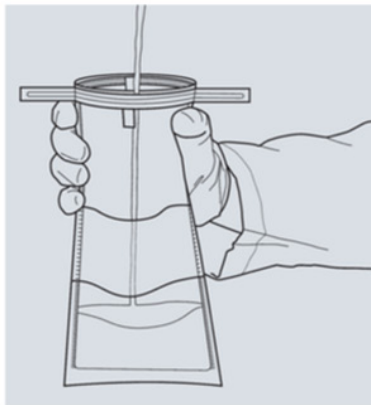

4. Open the tap and let it run for ~10 sec. Then, take a bit more than 100 ml of the sample.



5. Hold the bag by the wire ends and whirl it 3 - 4 times to make a seal.



6. Bring the two wire ends together and twist tie them

Figure 73: Sampling with a Whirl Pak ®, adapted from Whirl Pak ®

### With a sterile bottle

- Sterilize the sampling bottles with closed lid in boiling water or a pressure cooker for several minutes.
- On the day of sampling, take the closed bottles to the field and label them
- Disinfect the tap with a swipe of 80% Ethanol, then open the tap and let the water run for 5 - 10 seconds.
- Wash the bottle 3 times with the sample water.
- Fill the bottle with sample water (a bit more than 100ml).
- Take the lid, wash it 3 times with the sample water and close the bottle tightly
- Place the sample into the cooler bag/box and keep it cool and dark until analysed (max 6 hours). Analysis should be conducted within 6 hours.





Eawag  
Überlandstrasse 133  
8600 Dübendorf  
Switzerland  
Phone +41 (0)58 756 52 86  
[www.eawag.ch](http://www.eawag.ch)  
[www.sandec.ch](http://www.sandec.ch)

GDM video series:



Free digital copy:  
[www.sandec.ch/gdm-manual](http://www.sandec.ch/gdm-manual)

